

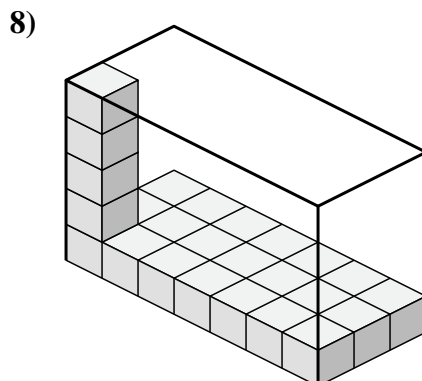

Déterminez le volume de chaque boîte. Chaque bloc correspond à 1 unité cubique (u³).

Réponses

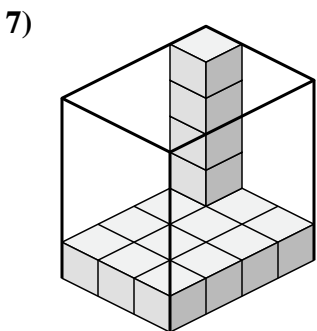
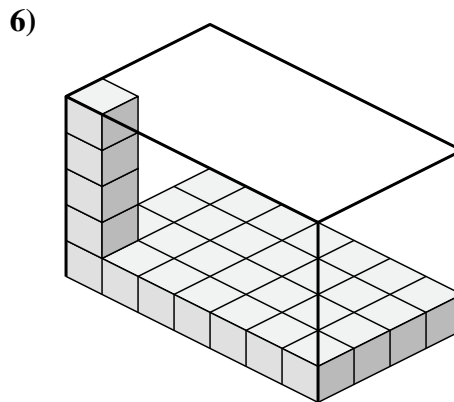
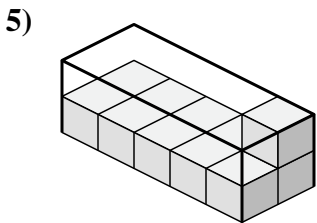
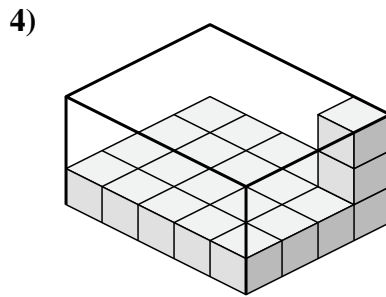
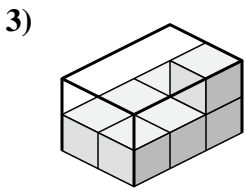
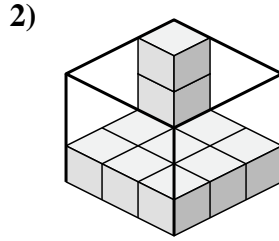
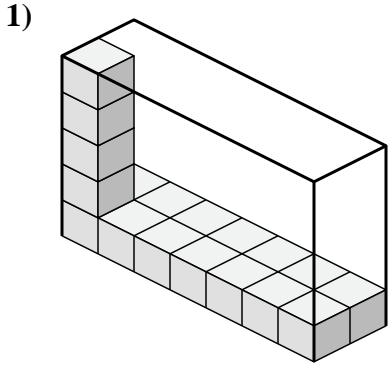

- 1. _____
- 2. _____
- 3. _____
- 4. _____
- 5. _____
- 6. _____
- 7. _____
- 8. _____



Déterminez le volume de chaque boîte. Chaque bloc correspond à 1 unité cubique (u³).

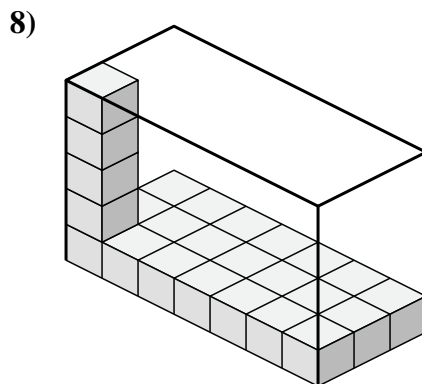
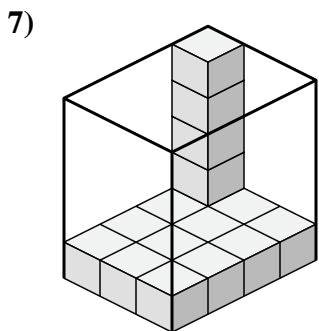
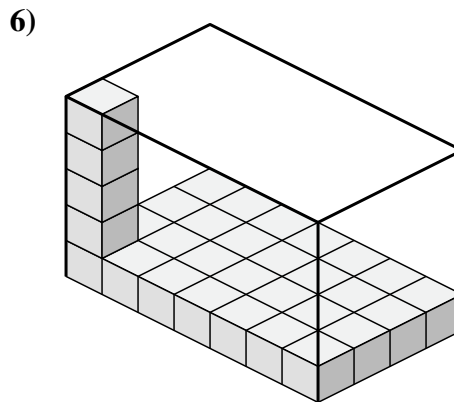
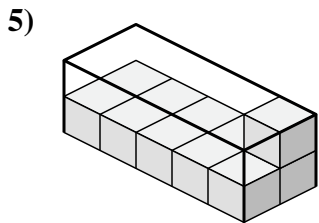
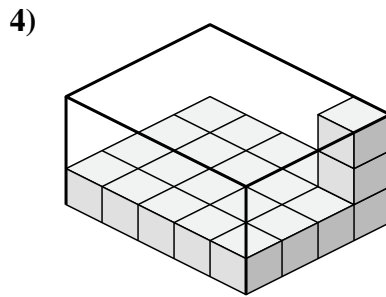
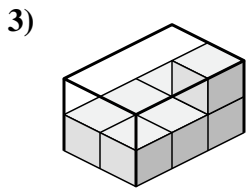
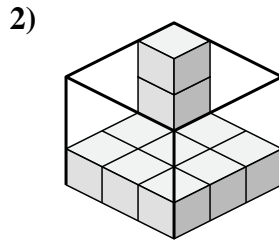
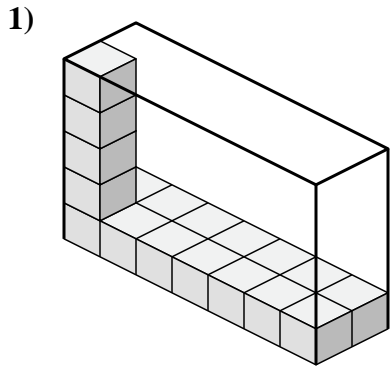

Réponses

1. 70 u³

2. 27 u³

3. 12 u³

4. 60 u³

5. 20 u³

6. 140 u³

7. 60 u³

8. 105 u³