

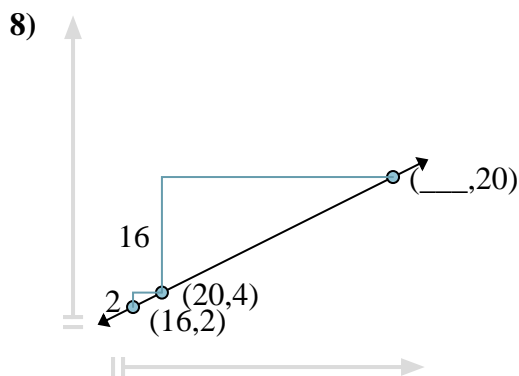

Trouvez la coordonnée manquante dans chaque problème.

Réponses

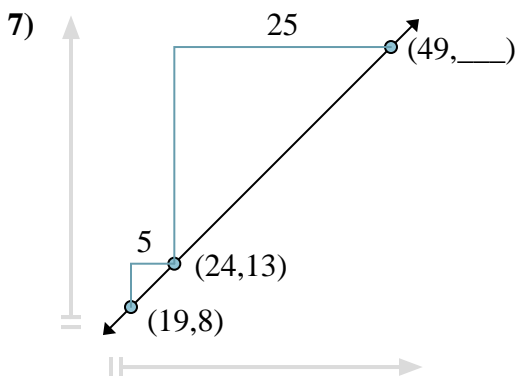
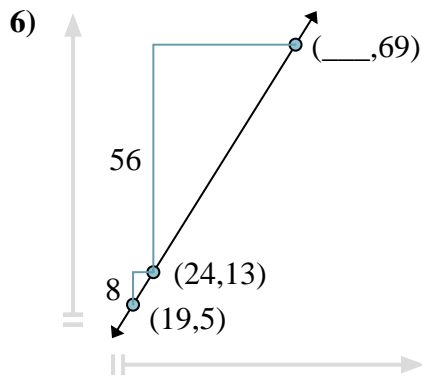
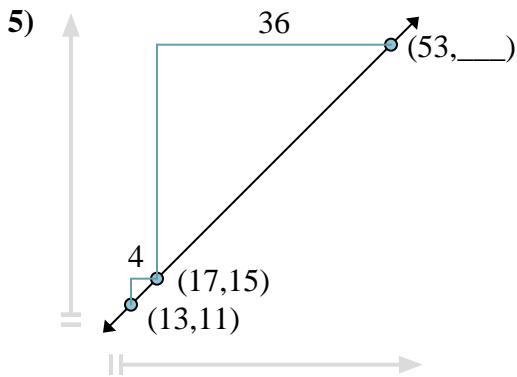
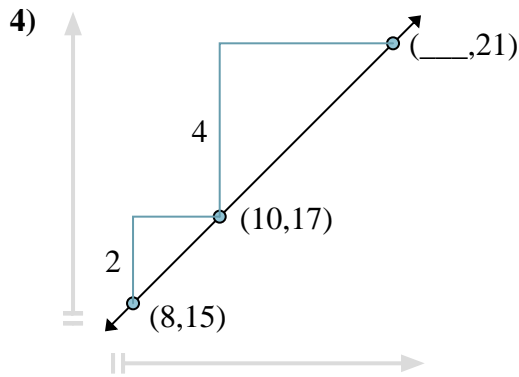
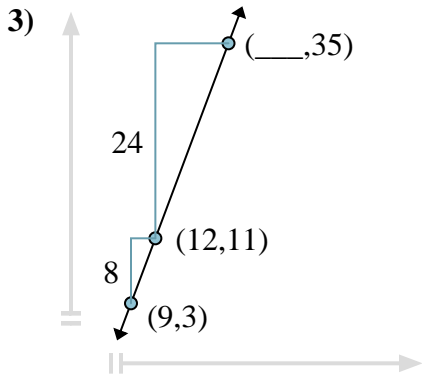
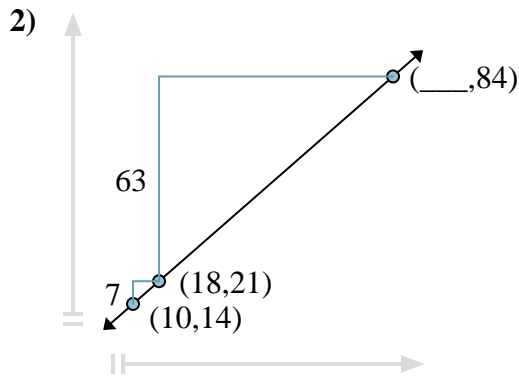
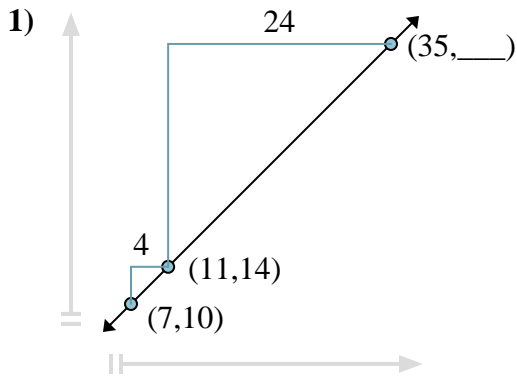

1. _____
2. _____
3. _____
4. _____
5. _____
6. _____
7. _____
8. _____

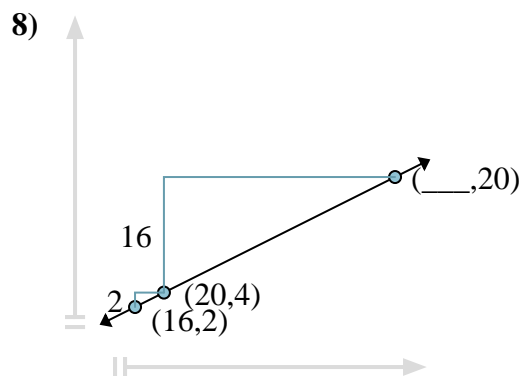
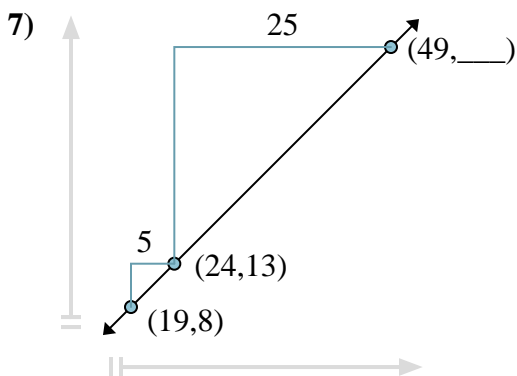
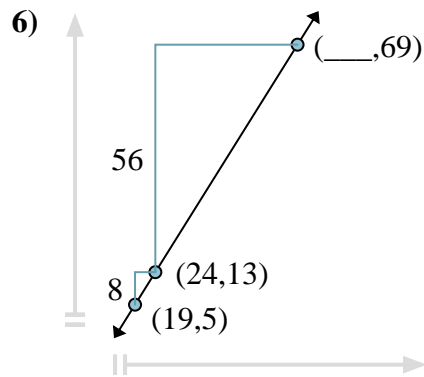
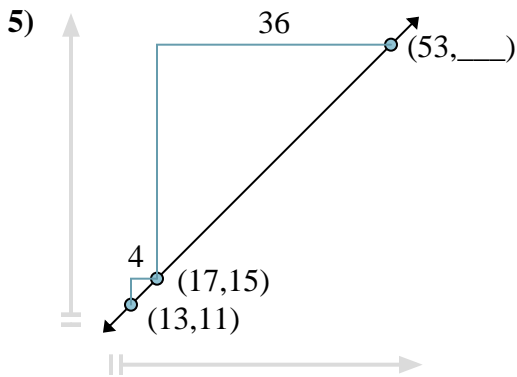
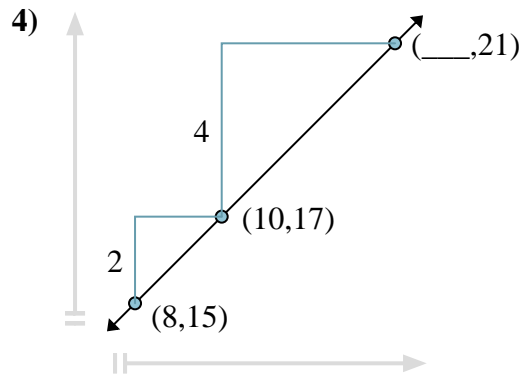
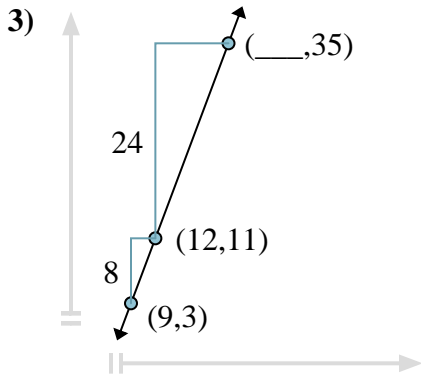
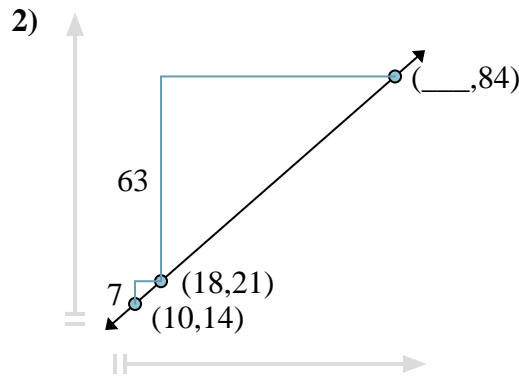
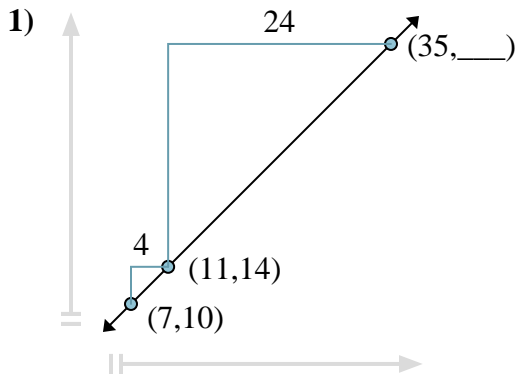

Trouvez la coordonnée manquante dans chaque problème.

**Réponses**

1. 38
2. 90
3. 21
4. 14
5. 51
6. 59
7. 38
8. 52



Trouvez la coordonnée manquante dans chaque problème.

Réponses

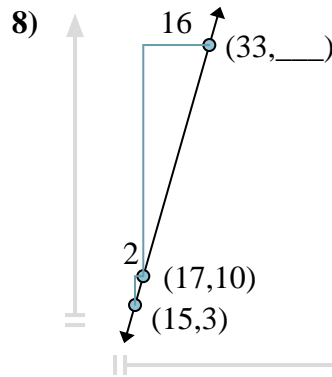
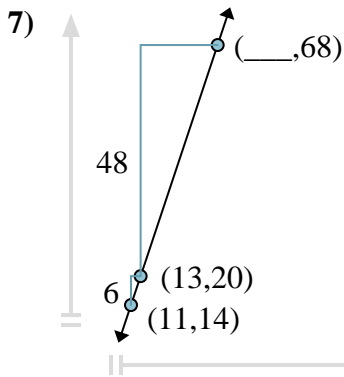
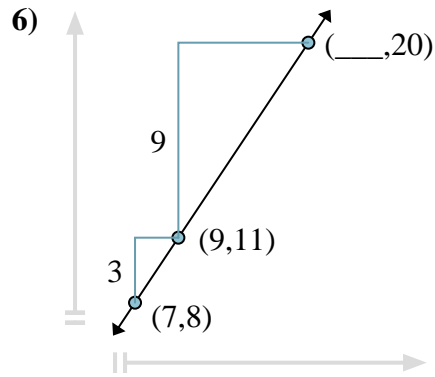
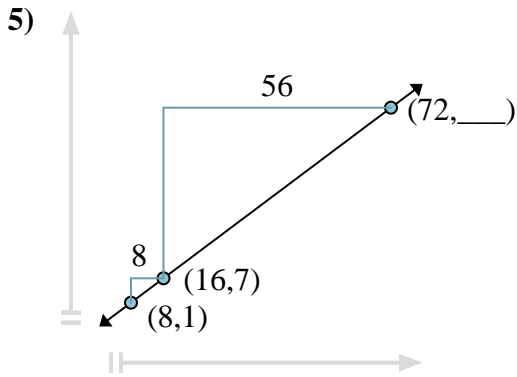
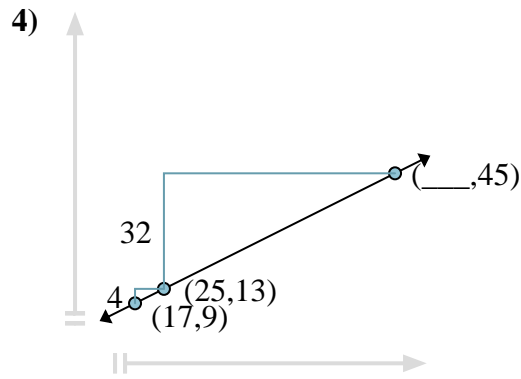
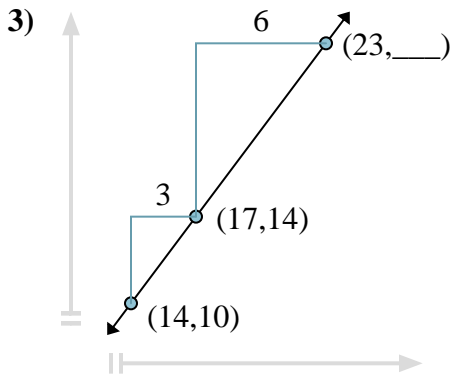
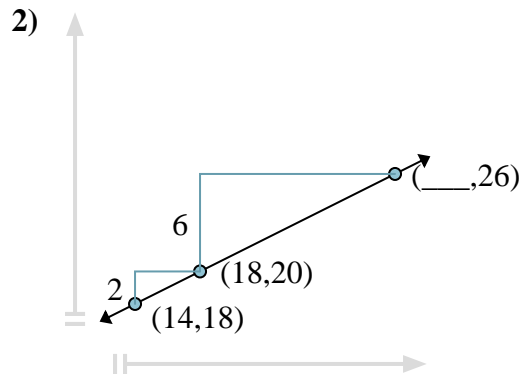
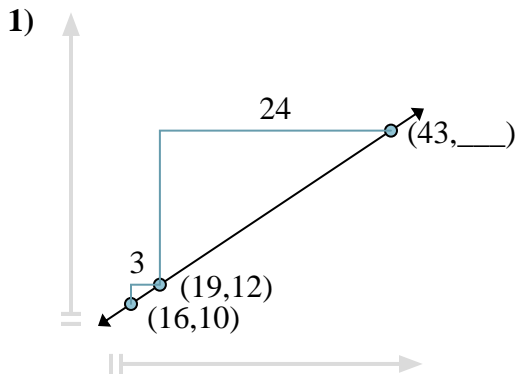

1. _____
2. _____
3. _____
4. _____
5. _____
6. _____
7. _____
8. _____



Trouvez la coordonnée manquante dans chaque problème.

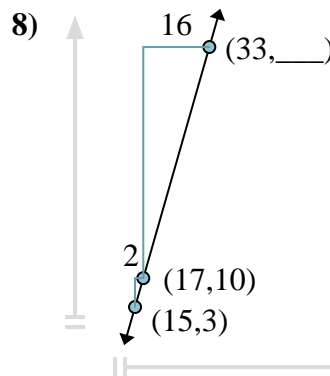
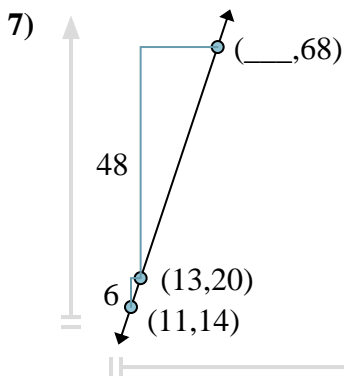
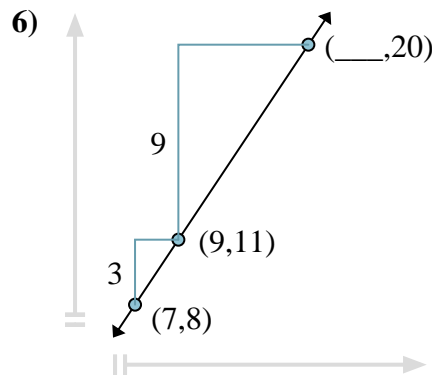
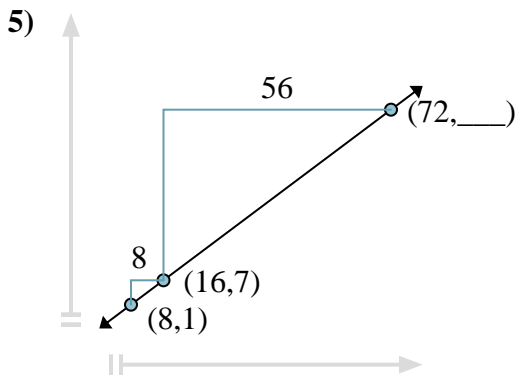
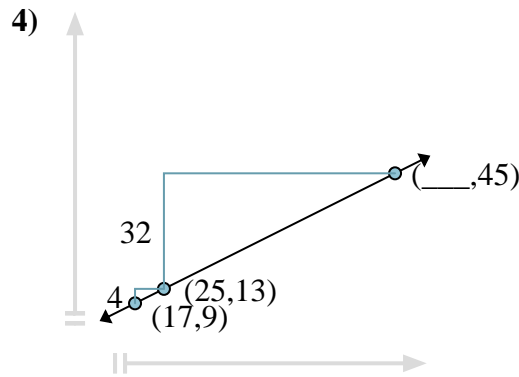
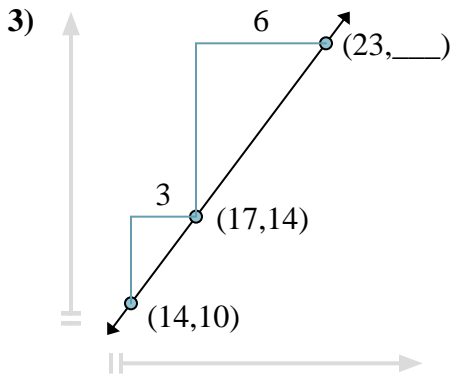
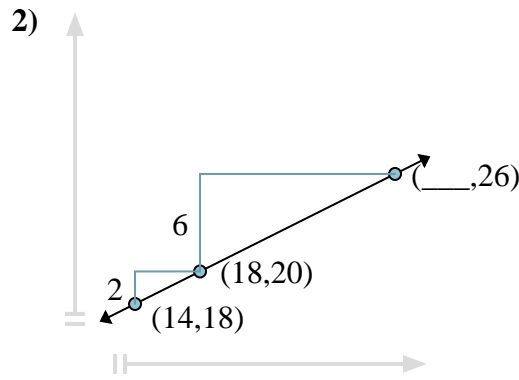
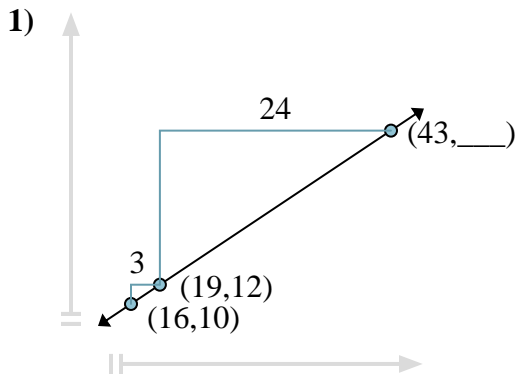

Réponses

1. 28
2. 30
3. 22
4. 89
5. 49
6. 15
7. 29
8. 66



Trouvez la coordonnée manquante dans chaque problème.

Réponses

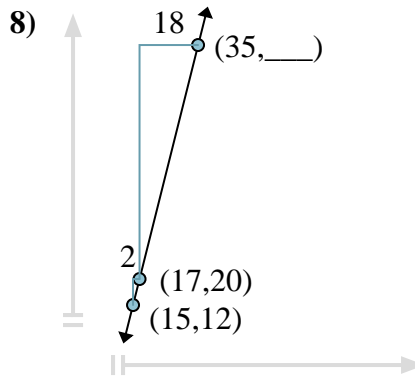
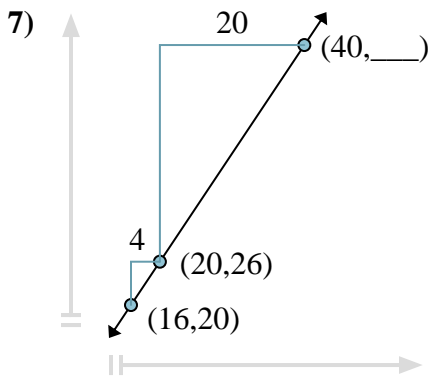
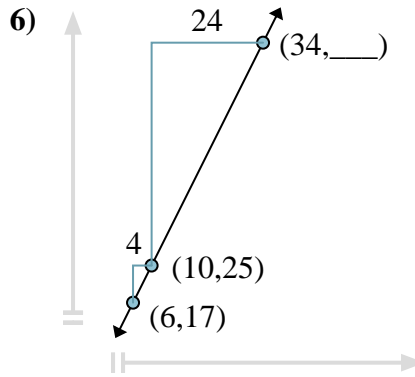
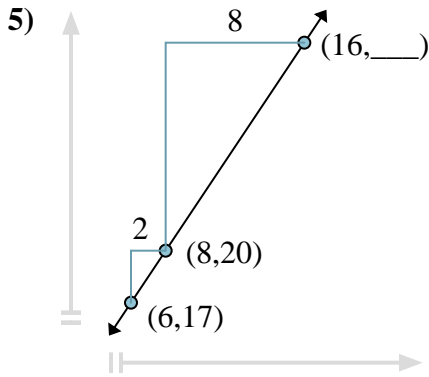
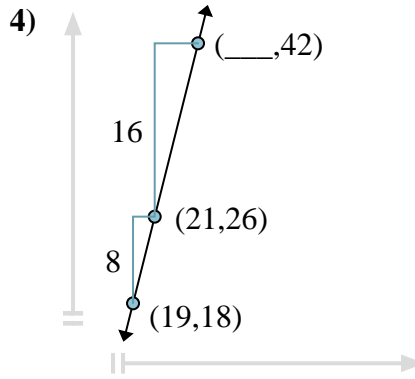
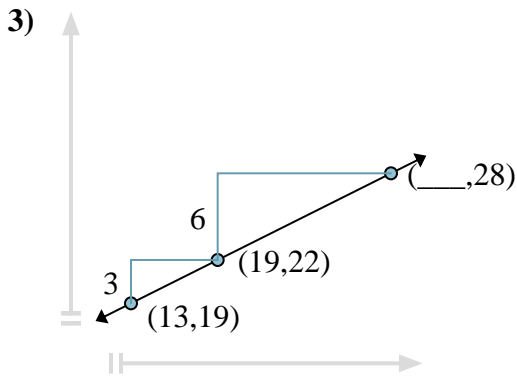
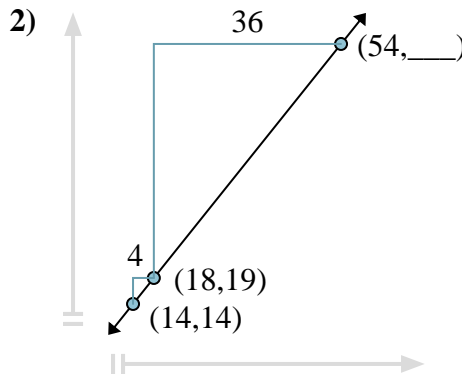
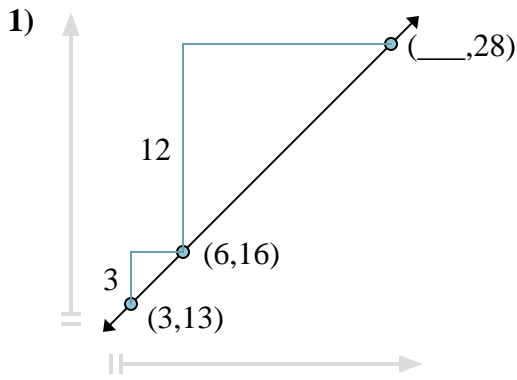

1. _____
2. _____
3. _____
4. _____
5. _____
6. _____
7. _____
8. _____

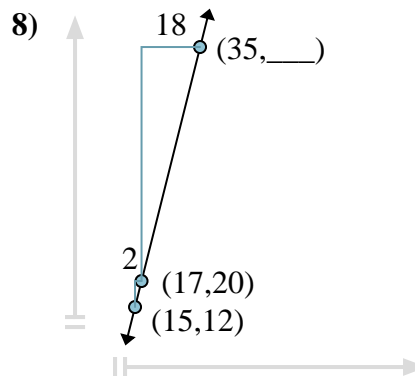
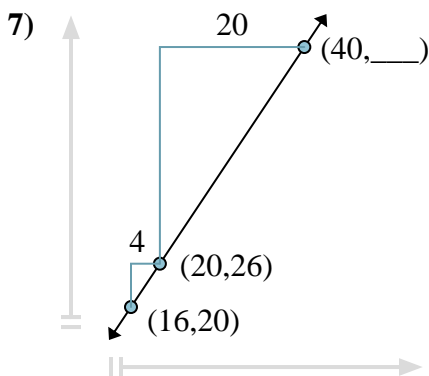
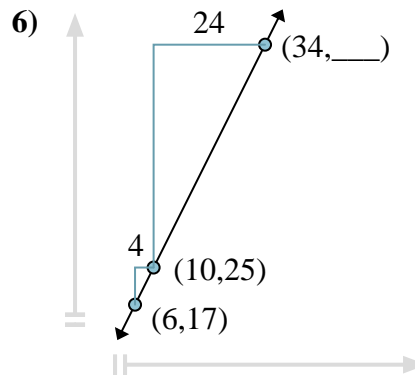
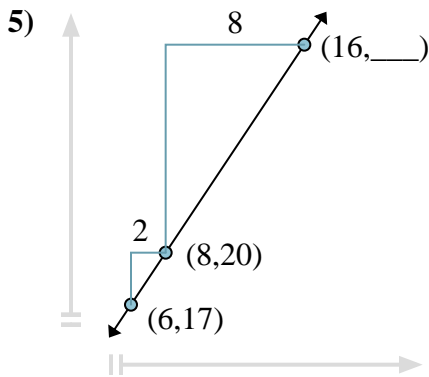
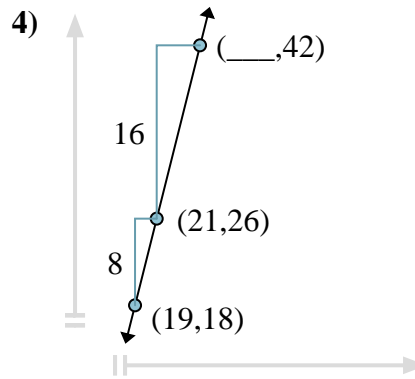
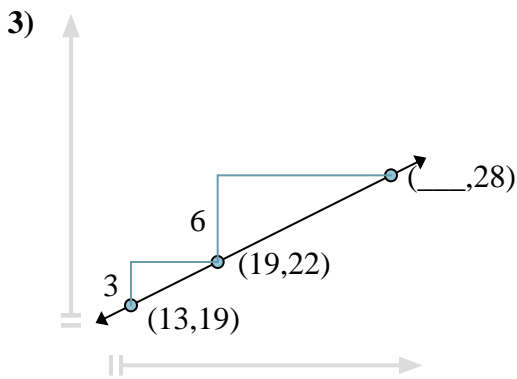
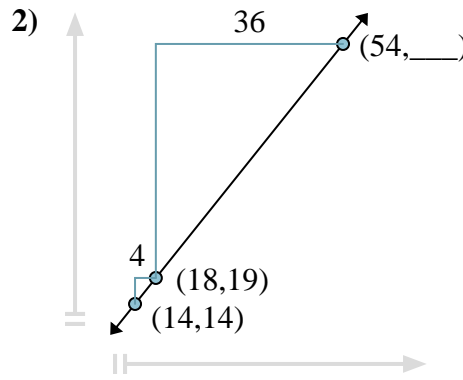
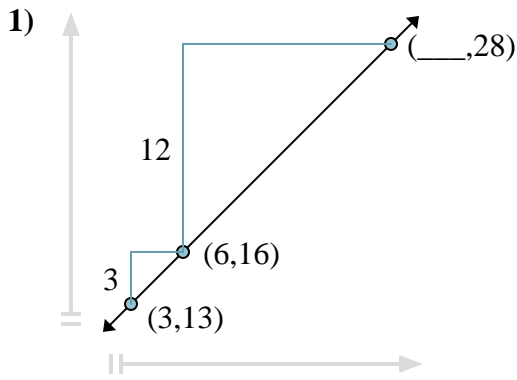

Trouvez la coordonnée manquante dans chaque problème.

Réponses

1. 18
2. 64
3. 31
4. 25
5. 32
6. 73
7. 56
8. 92



Trouvez la coordonnée manquante dans chaque problème.

Réponses

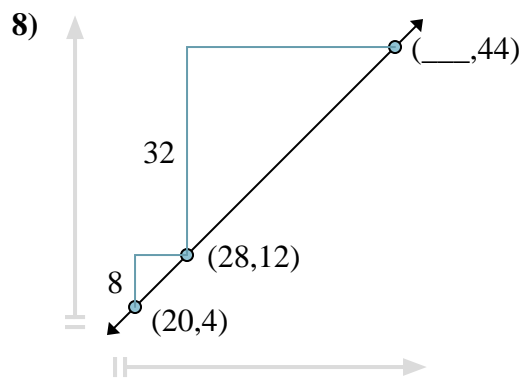
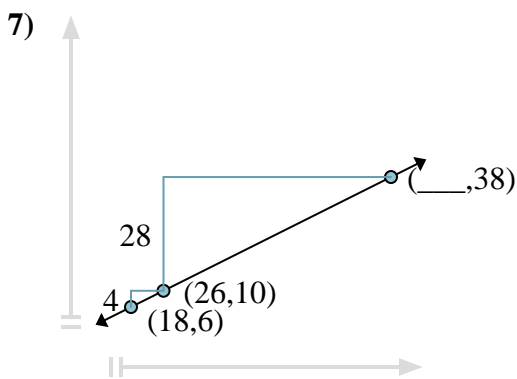
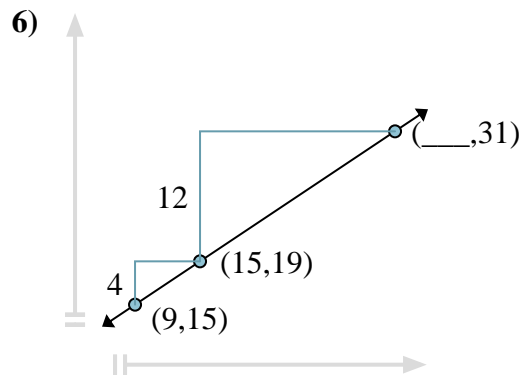
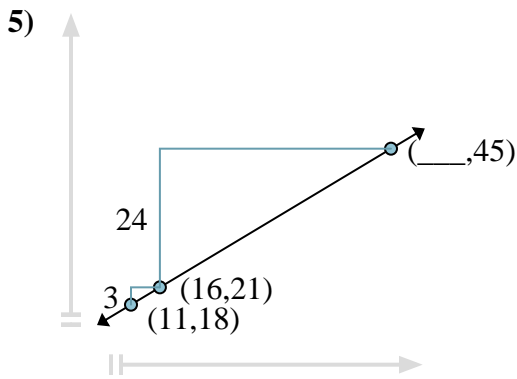
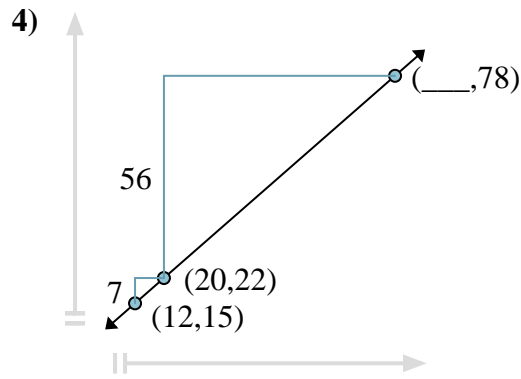
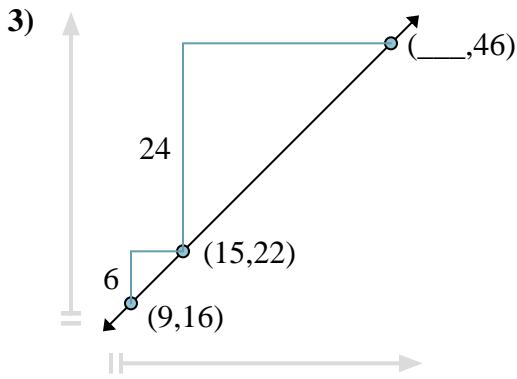
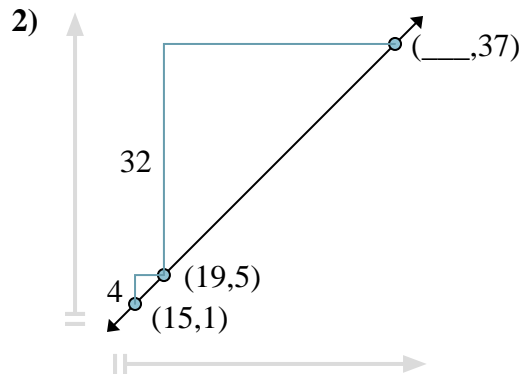
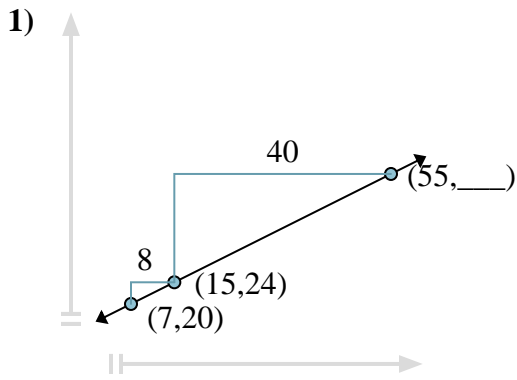

1. _____
2. _____
3. _____
4. _____
5. _____
6. _____
7. _____
8. _____



Trouvez la coordonnée manquante dans chaque problème.

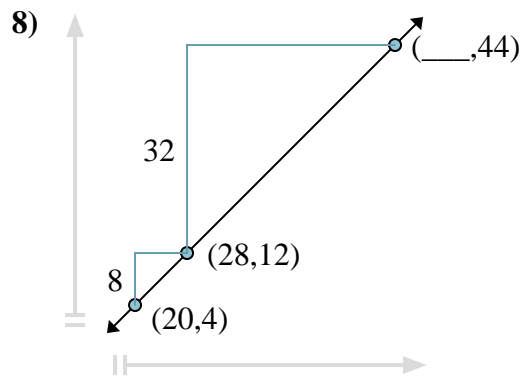
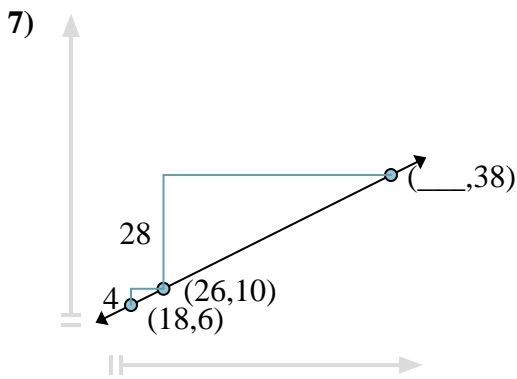
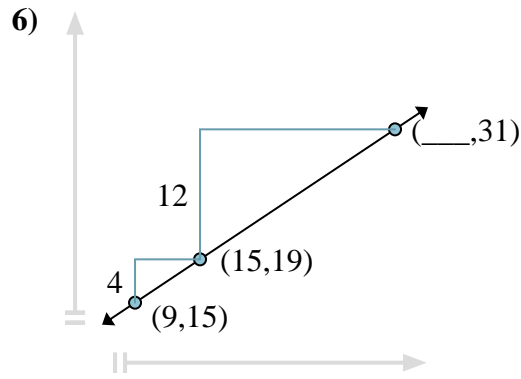
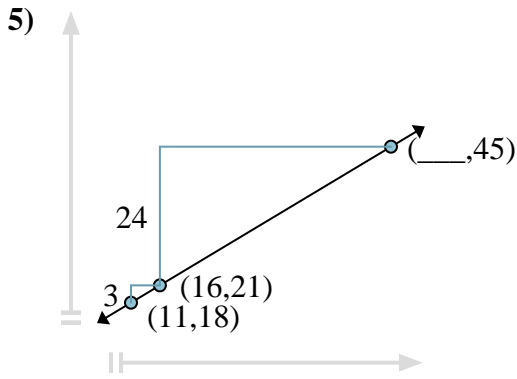
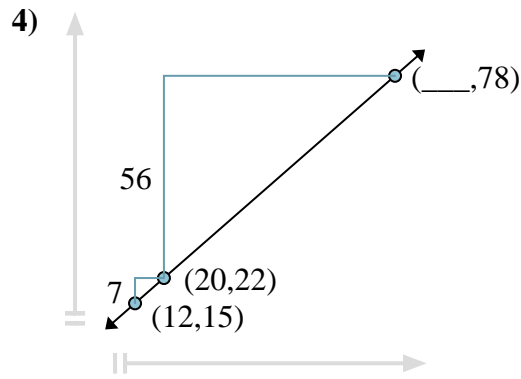
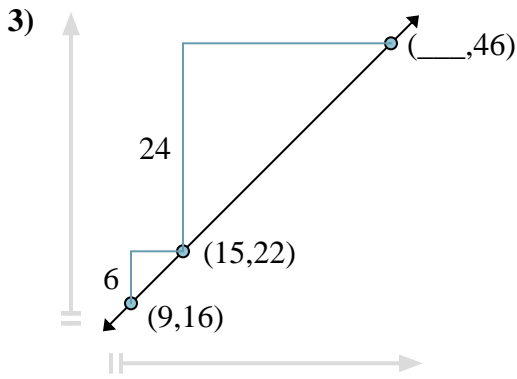
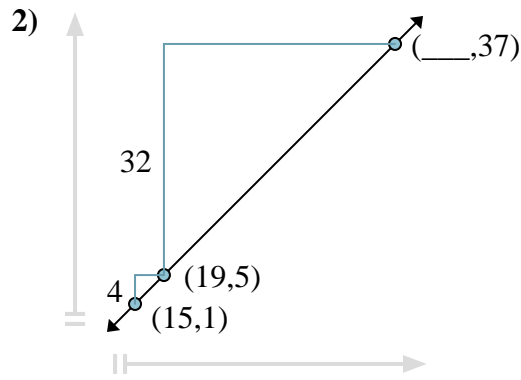
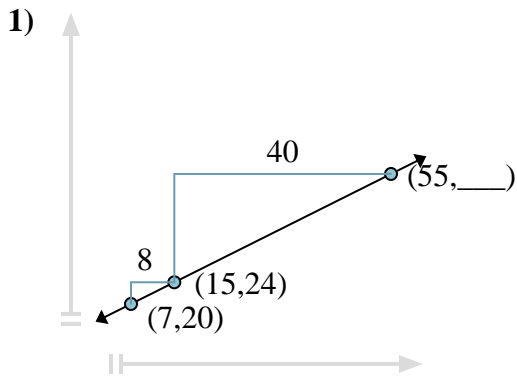

Réponses

1. 44
2. 51
3. 39
4. 84
5. 56
6. 33
7. 82
8. 60



Trouvez la coordonnée manquante dans chaque problème.

Réponses

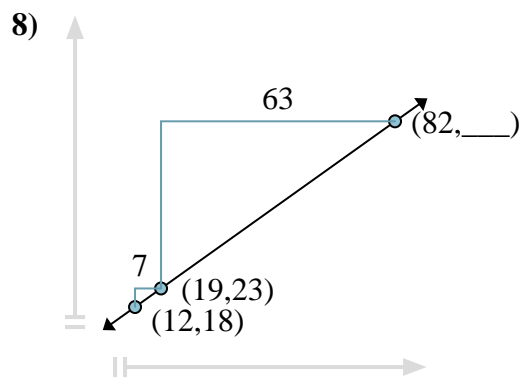
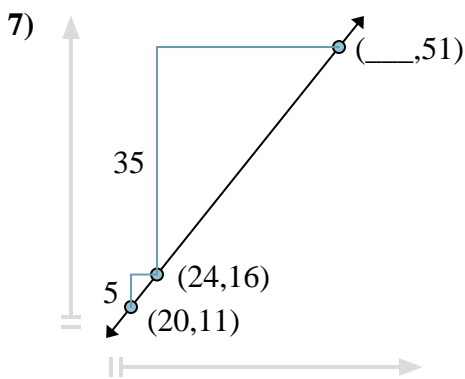
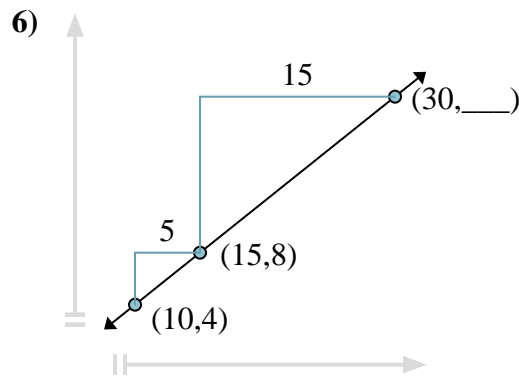
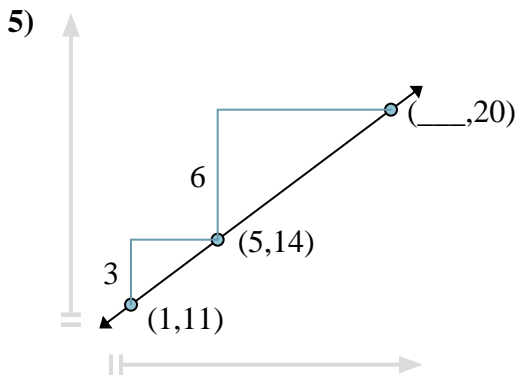
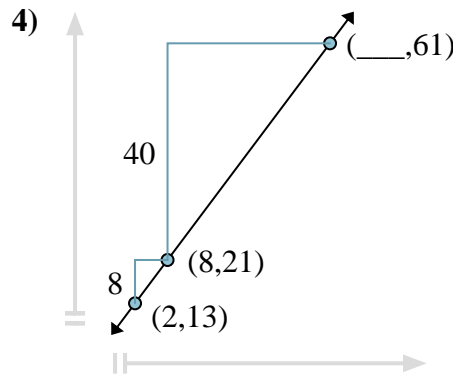
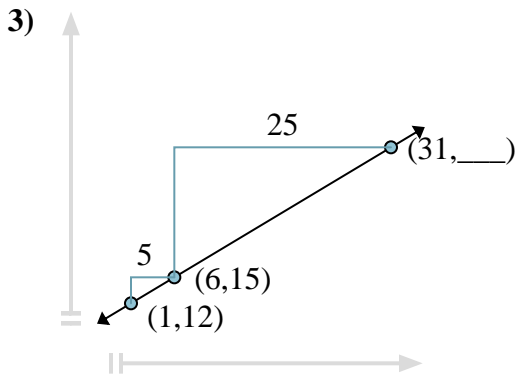
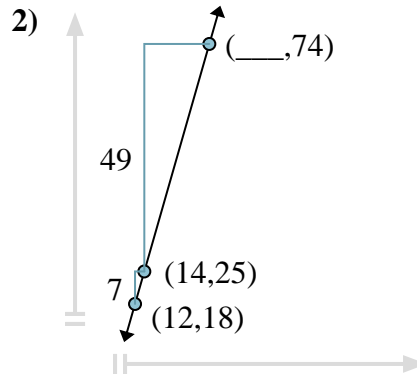
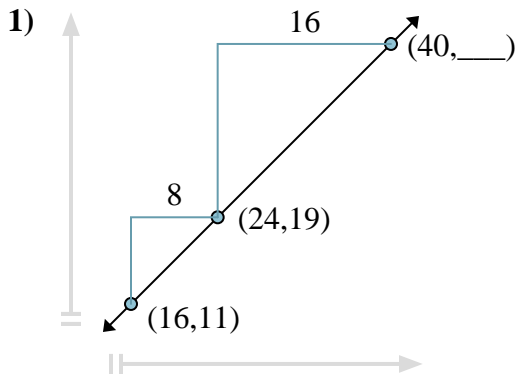

1. _____
2. _____
3. _____
4. _____
5. _____
6. _____
7. _____
8. _____

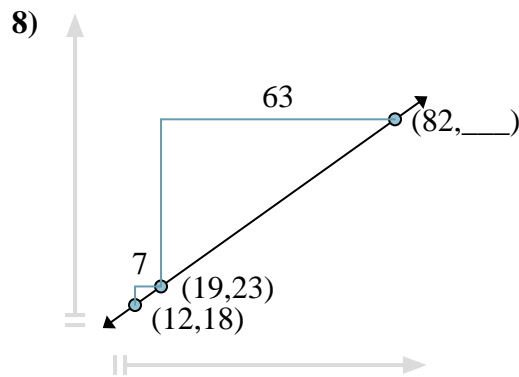
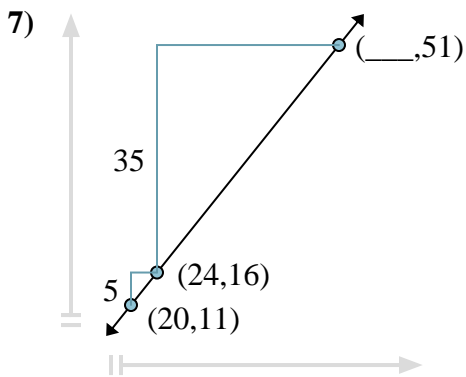
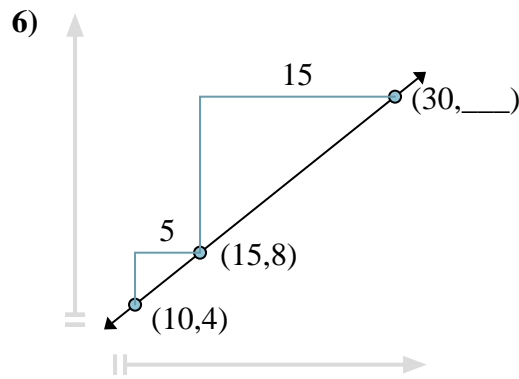
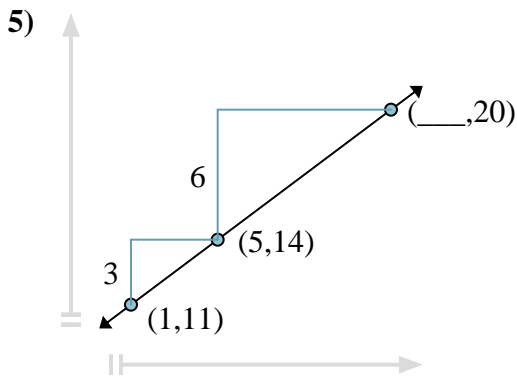
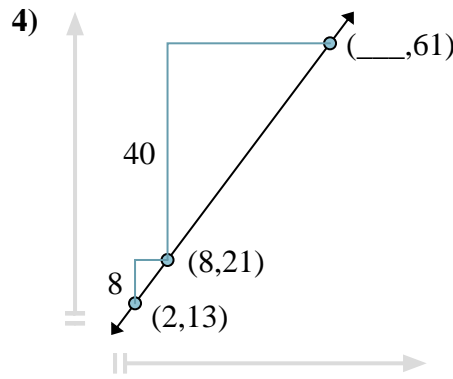
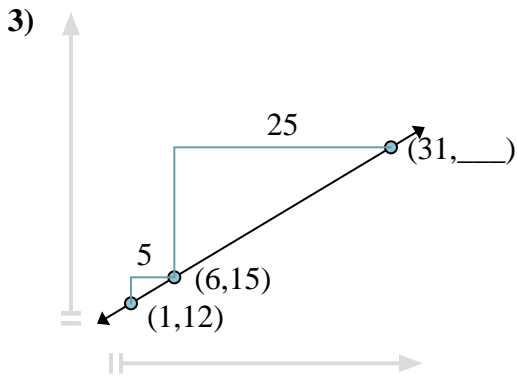
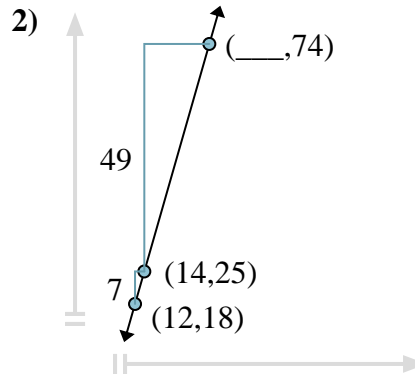
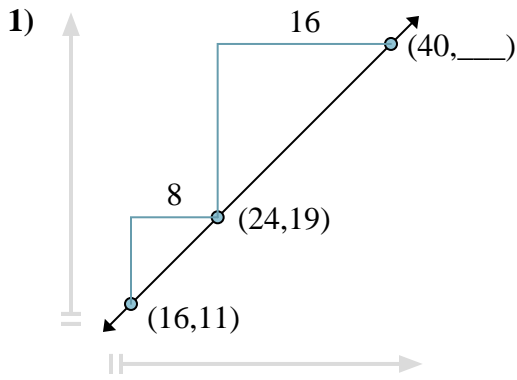

Trouvez la coordonnée manquante dans chaque problème.

Réponses

1. 35
2. 28
3. 30
4. 38
5. 13
6. 20
7. 52
8. 68



Trouvez la coordonnée manquante dans chaque problème.

Réponses

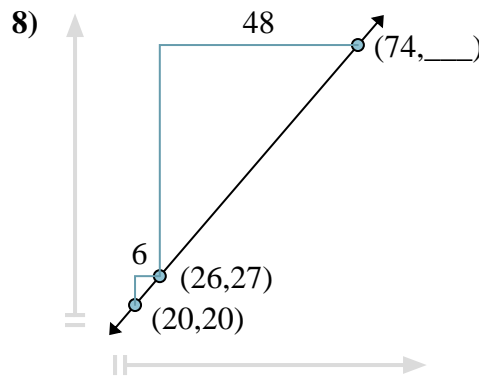
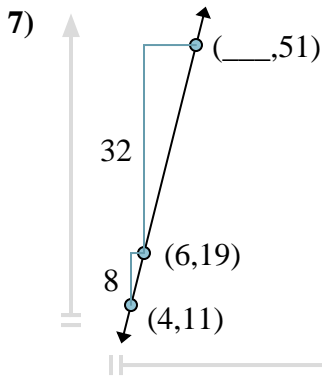
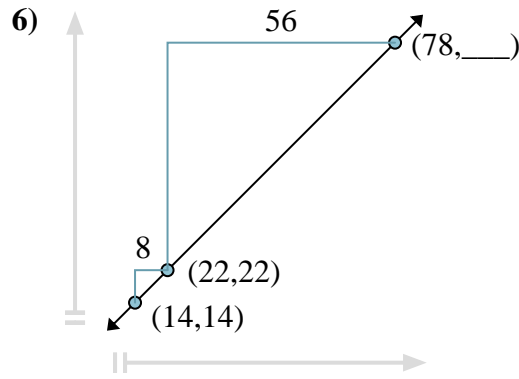
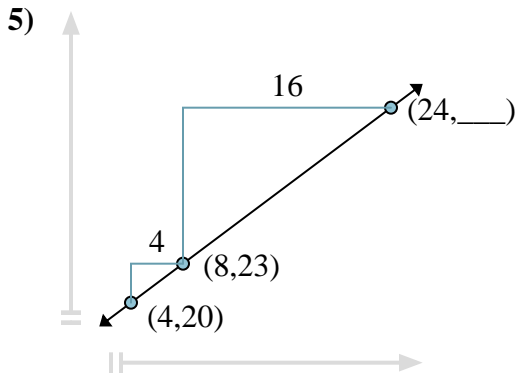
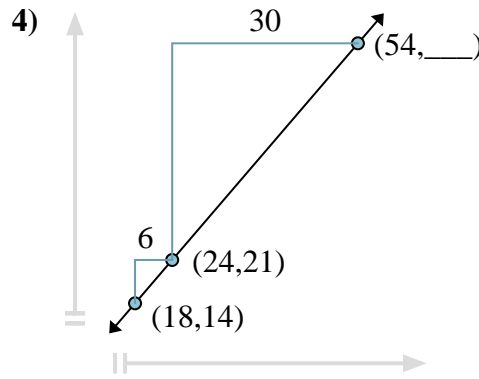
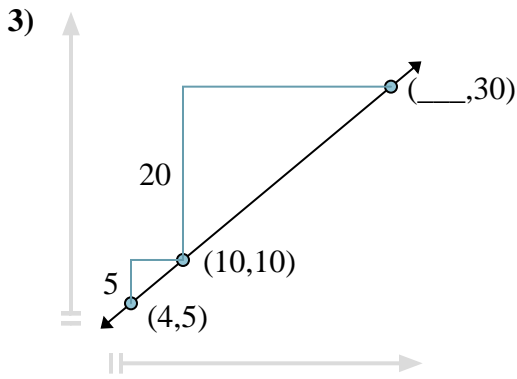
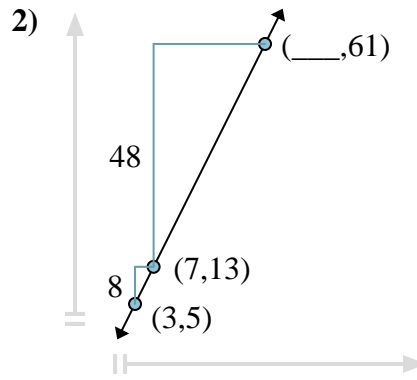
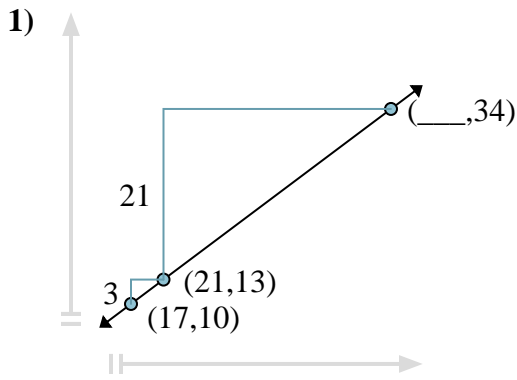

1. _____
2. _____
3. _____
4. _____
5. _____
6. _____
7. _____
8. _____



Trouvez la coordonnée manquante dans chaque problème.

Réponses

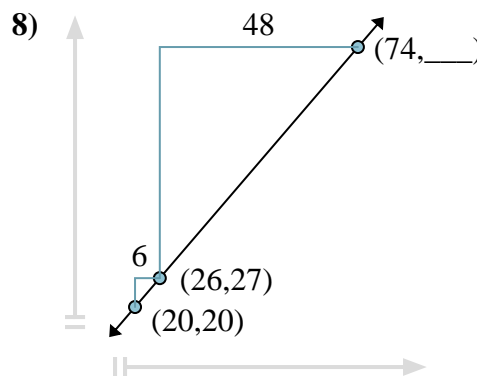
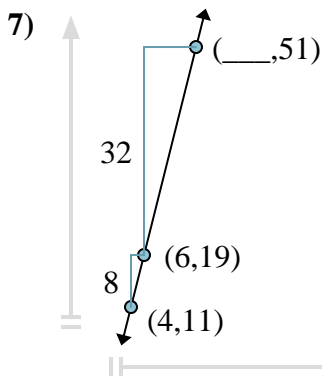
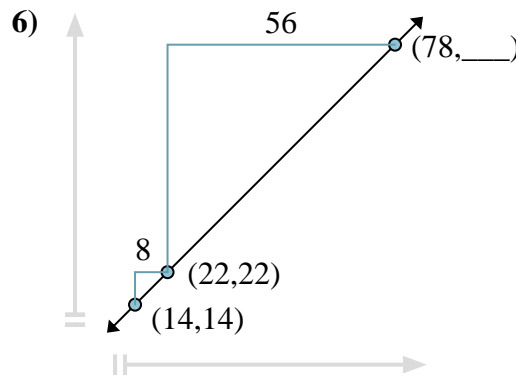
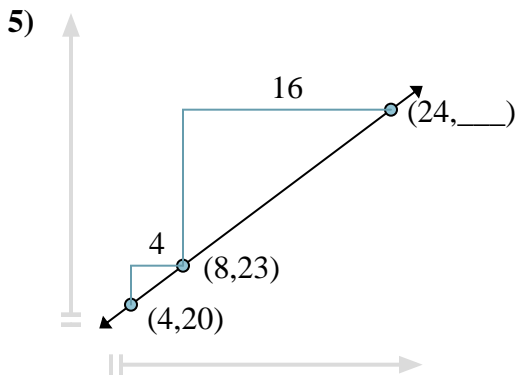
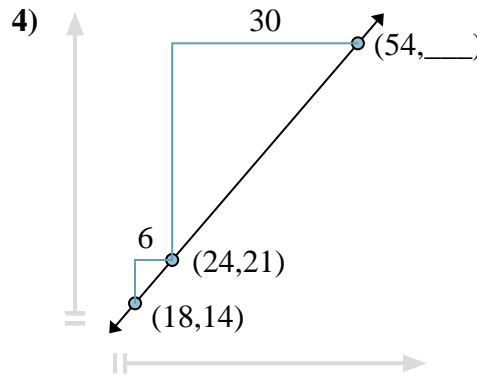
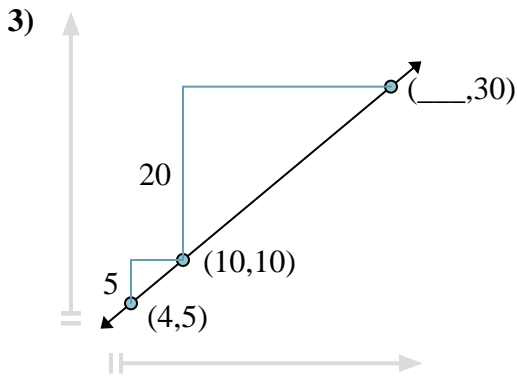
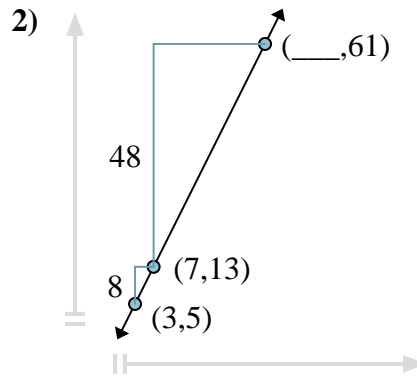
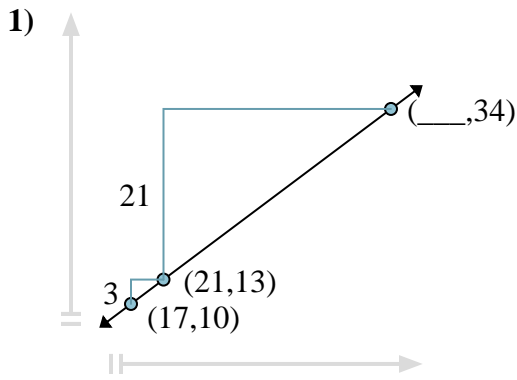

1. 49
2. 31
3. 34
4. 56
5. 35
6. 78
7. 14
8. 83



Trouvez la coordonnée manquante dans chaque problème.

Réponses

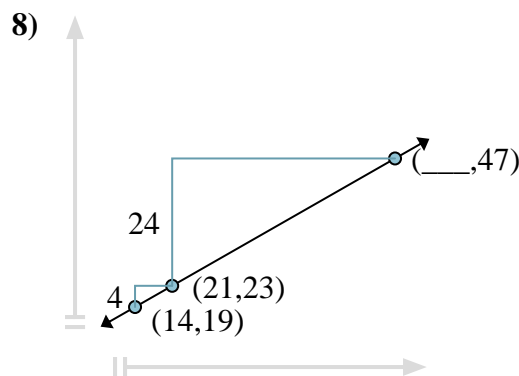
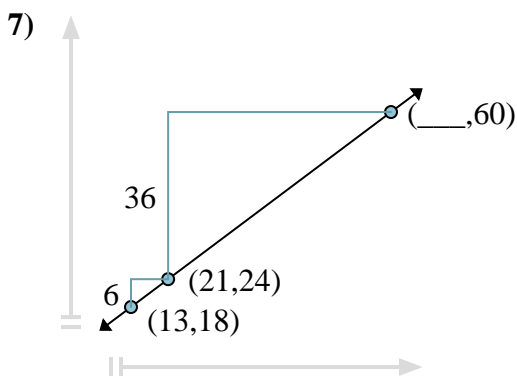
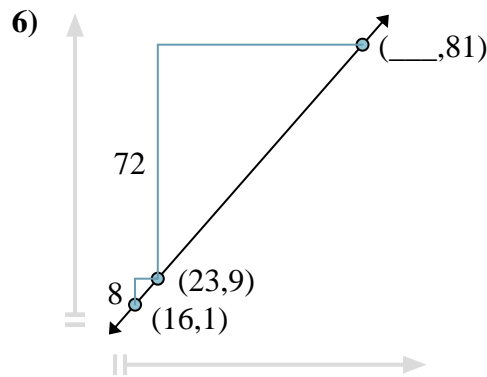
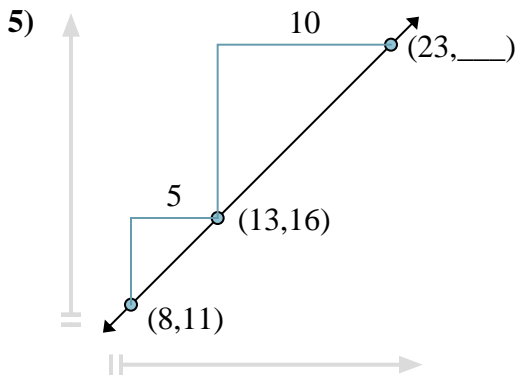
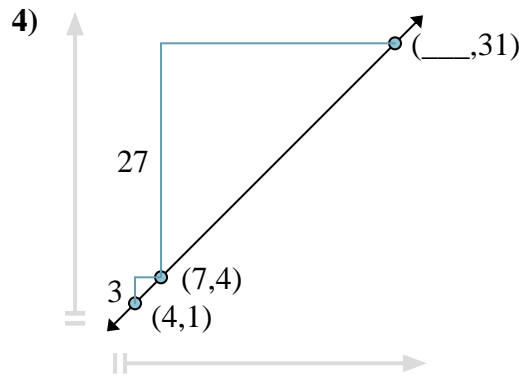
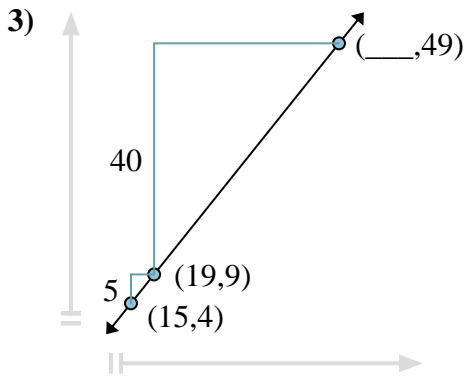
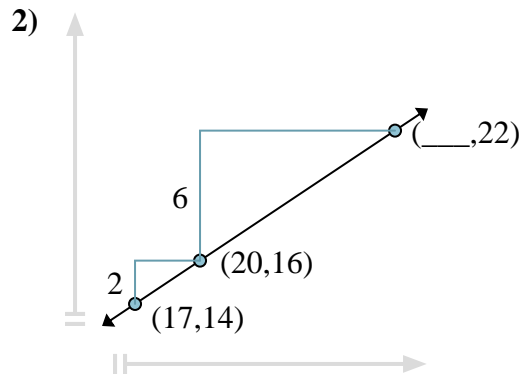
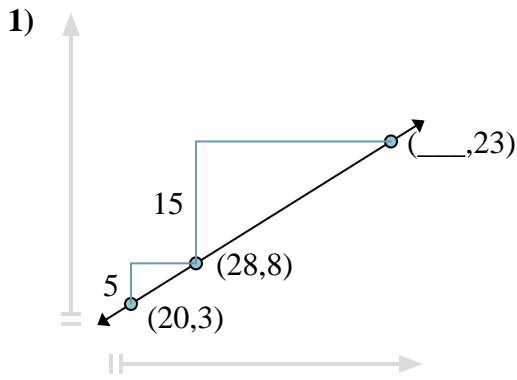

1. _____
2. _____
3. _____
4. _____
5. _____
6. _____
7. _____
8. _____



Trouvez la coordonnée manquante dans chaque problème.

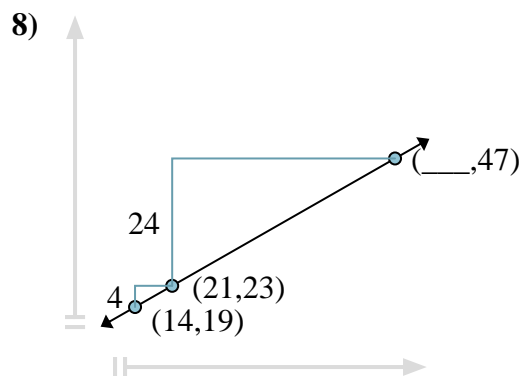
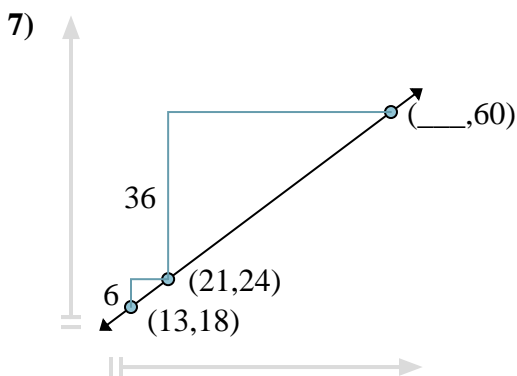
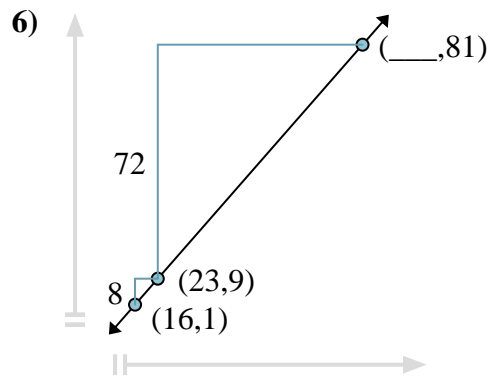
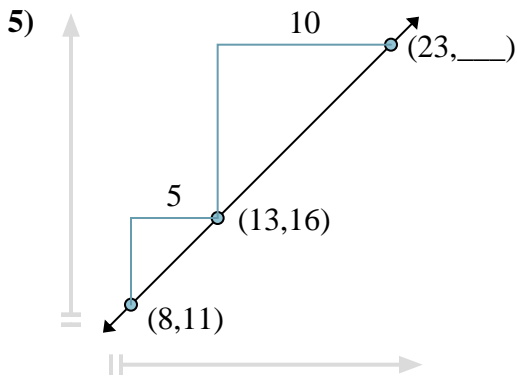
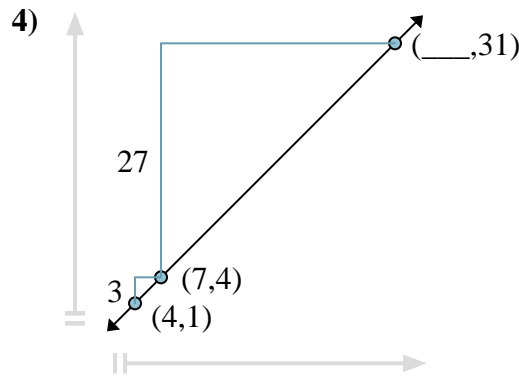
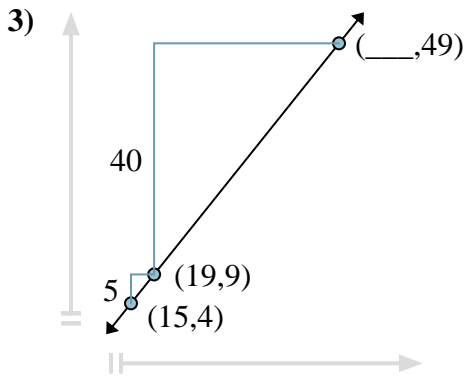
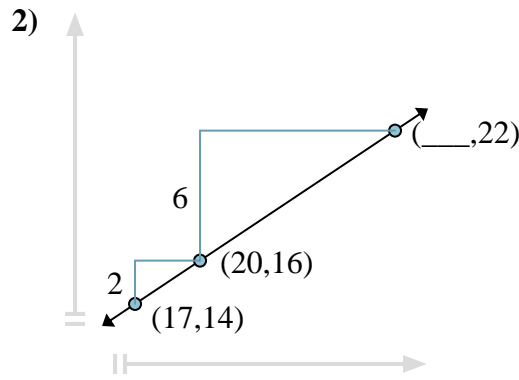
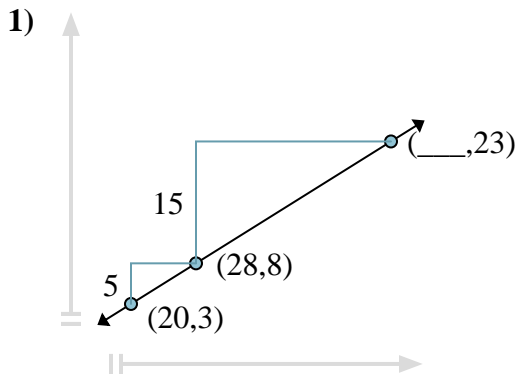

Réponses

1. 52
2. 29
3. 51
4. 34
5. 26
6. 86
7. 69
8. 63



Trouvez la coordonnée manquante dans chaque problème.

Réponses

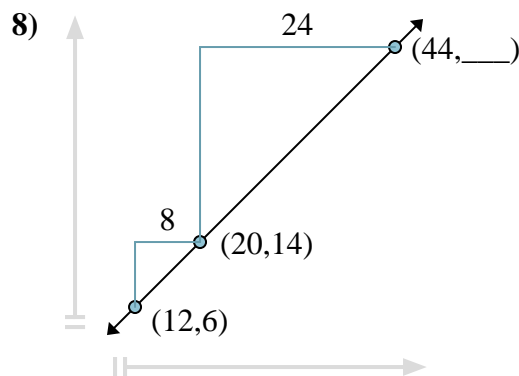
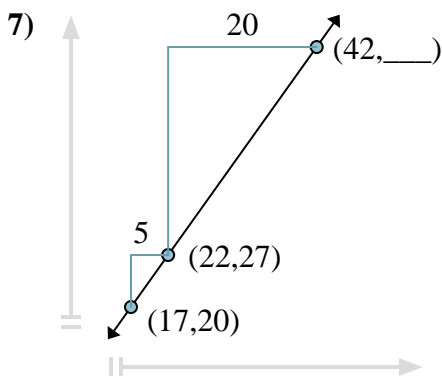
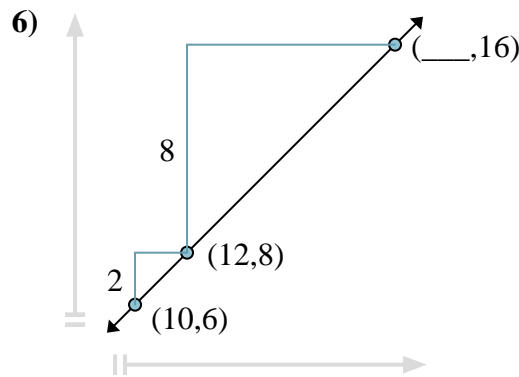
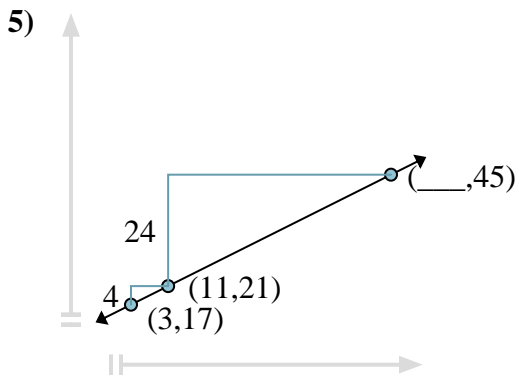
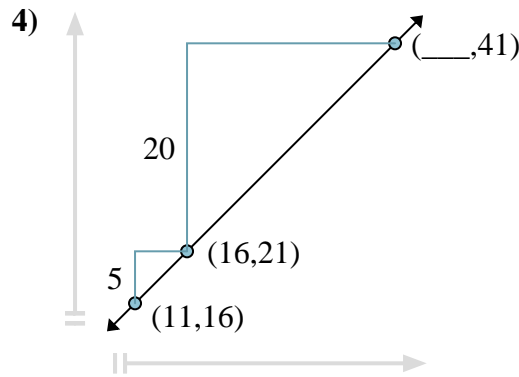
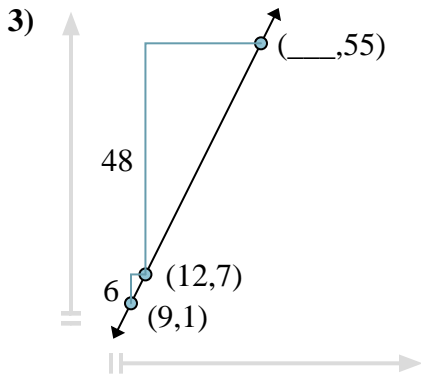
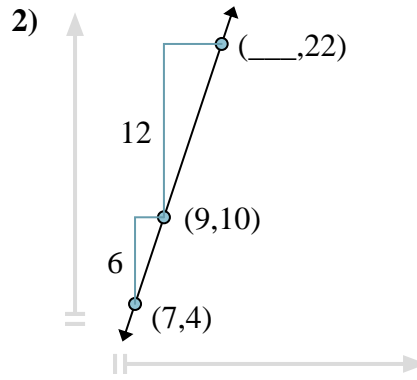
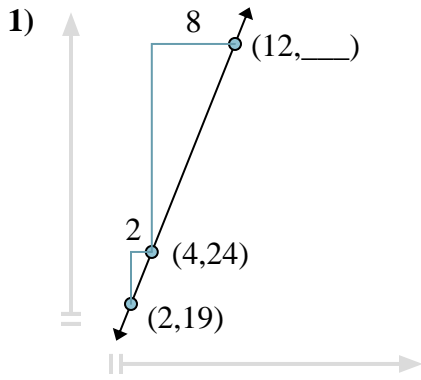

1. _____
2. _____
3. _____
4. _____
5. _____
6. _____
7. _____
8. _____



Trouvez la coordonnée manquante dans chaque problème.

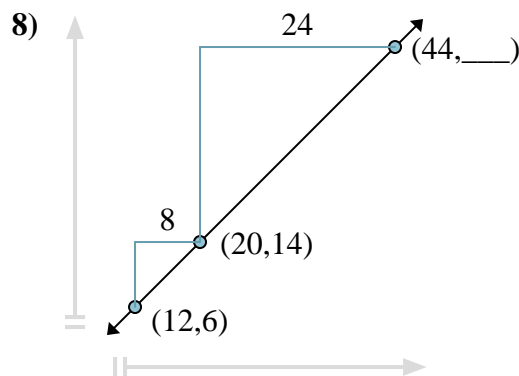
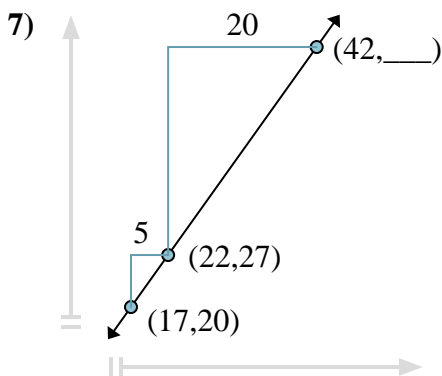
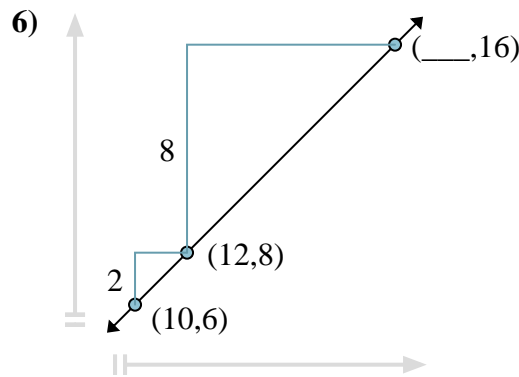
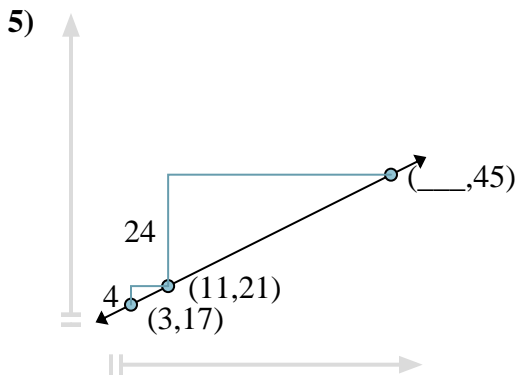
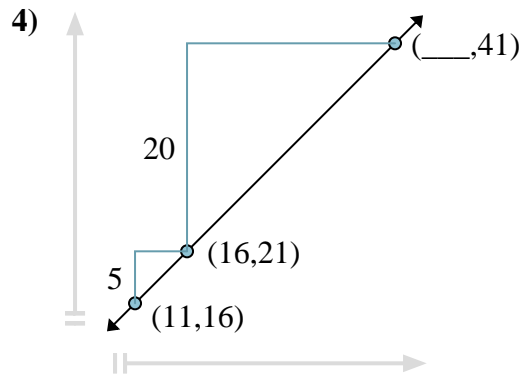
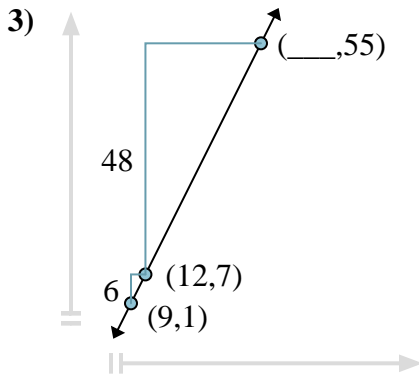
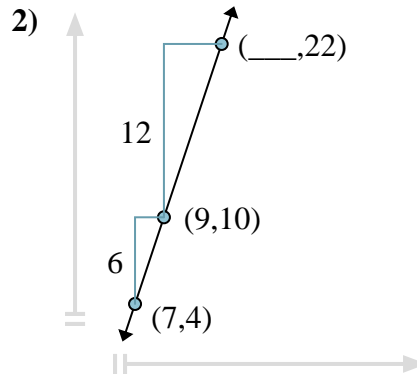
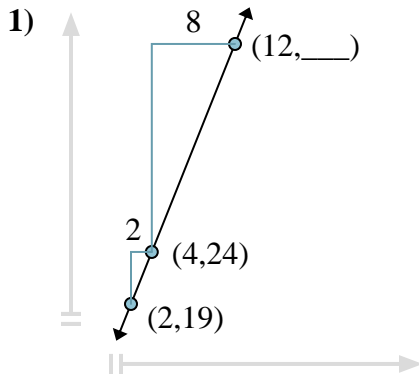

Réponses

1. 44
2. 13
3. 36
4. 36
5. 59
6. 20
7. 55
8. 38



Trouvez la coordonnée manquante dans chaque problème.

Réponses

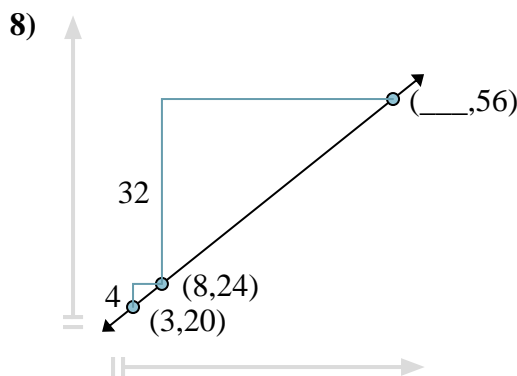
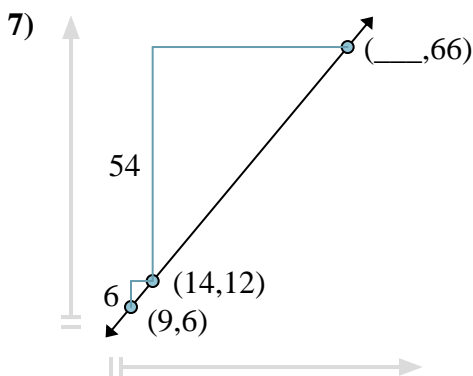
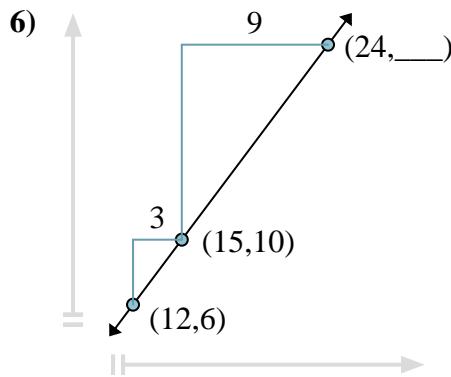
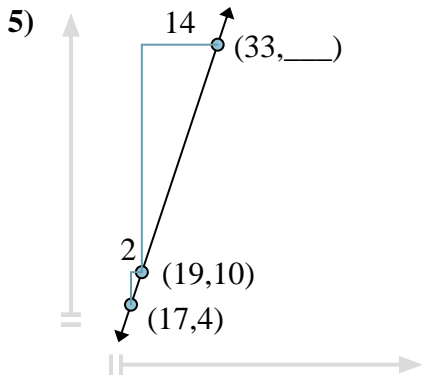
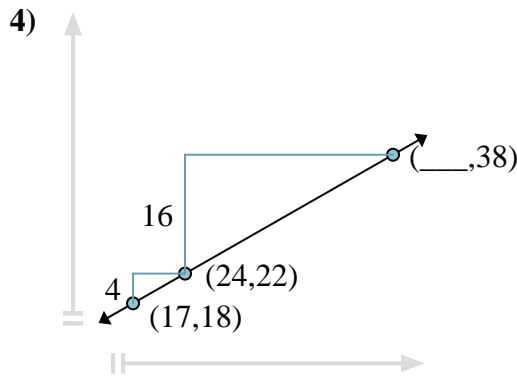
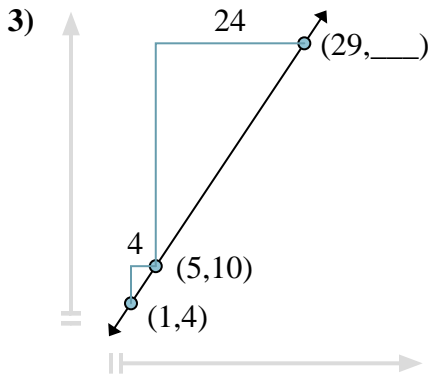
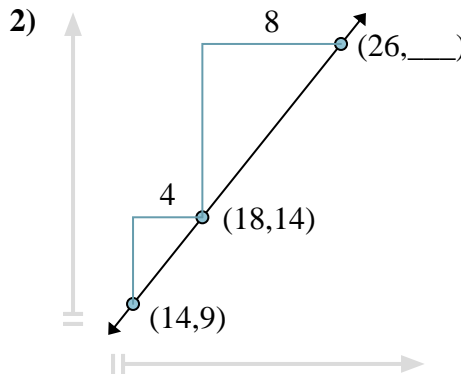
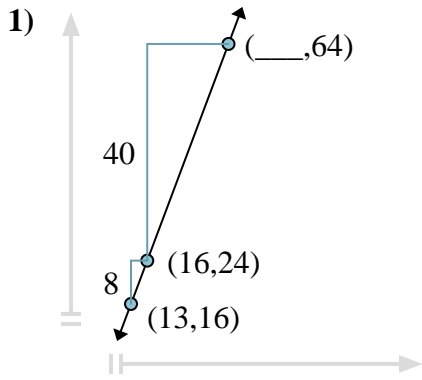

1. _____
2. _____
3. _____
4. _____
5. _____
6. _____
7. _____
8. _____

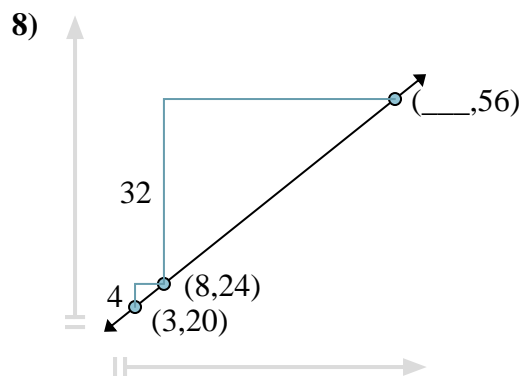
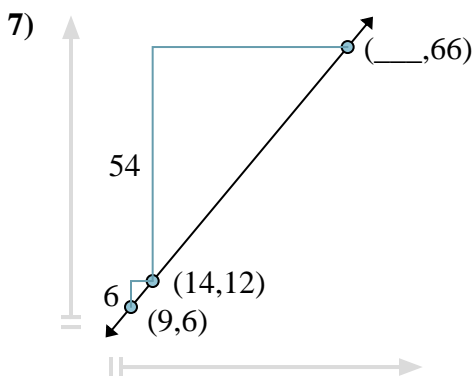
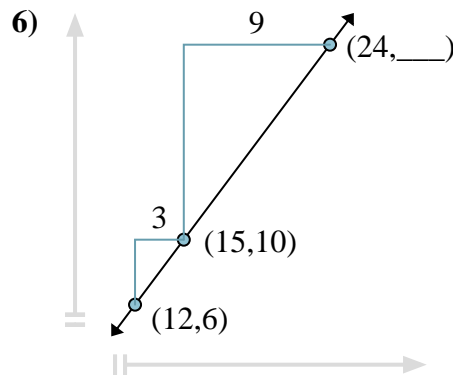
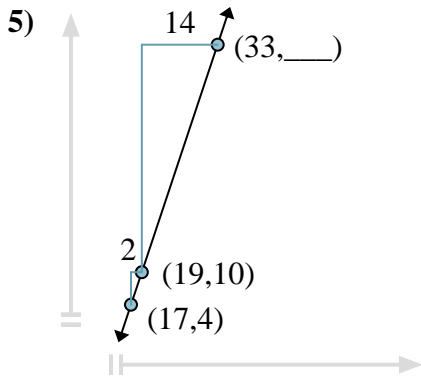
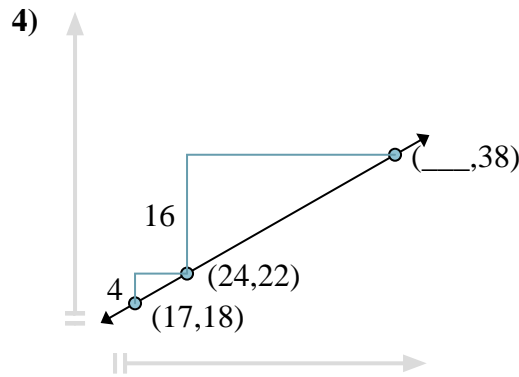
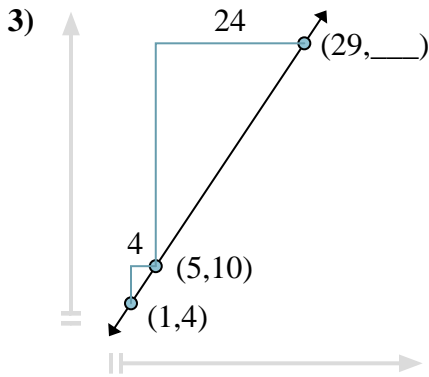
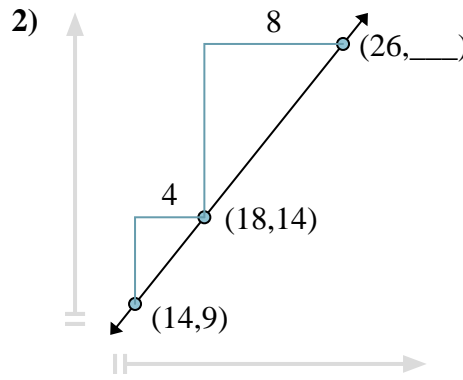
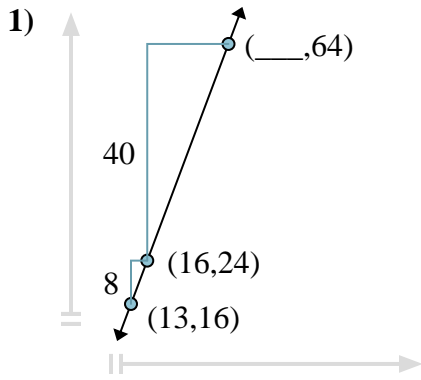

Trouvez la coordonnée manquante dans chaque problème.

Réponses

1. 31
2. 24
3. 46
4. 52
5. 52
6. 22
7. 59
8. 48



Trouvez la coordonnée manquante dans chaque problème.

Réponses

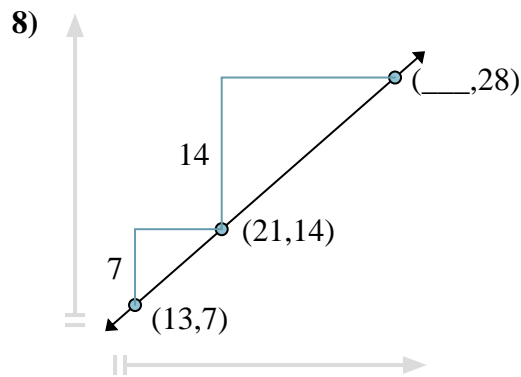
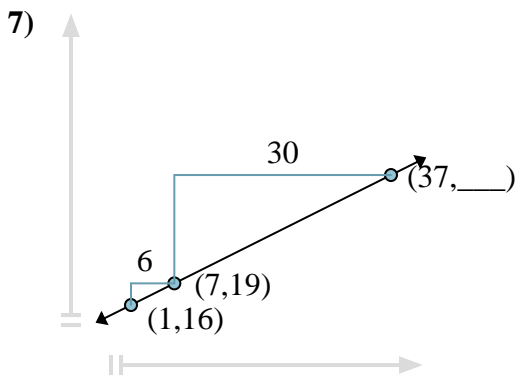
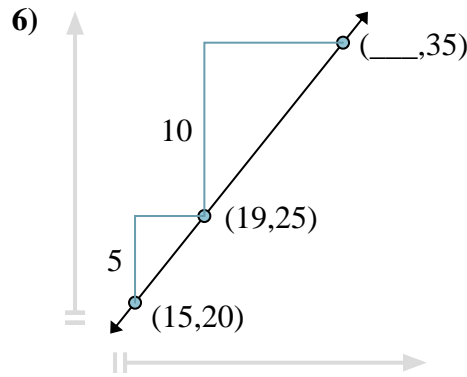
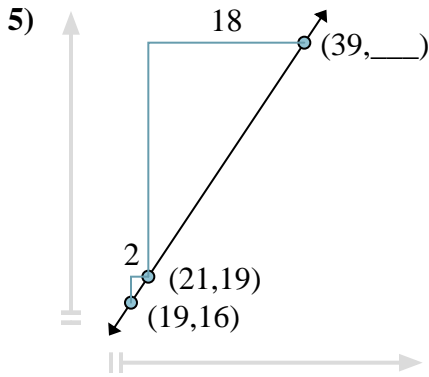
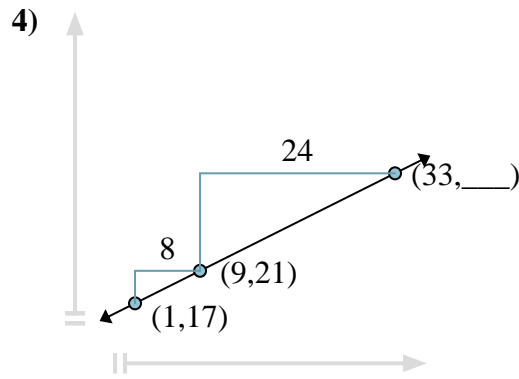
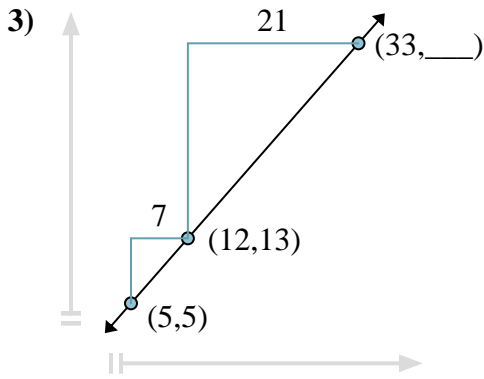
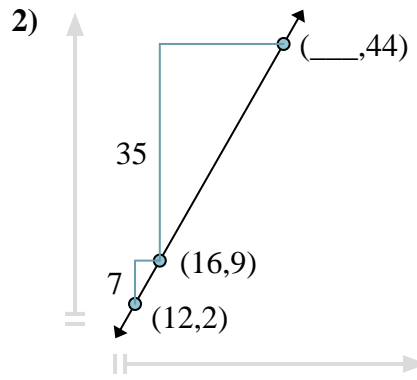
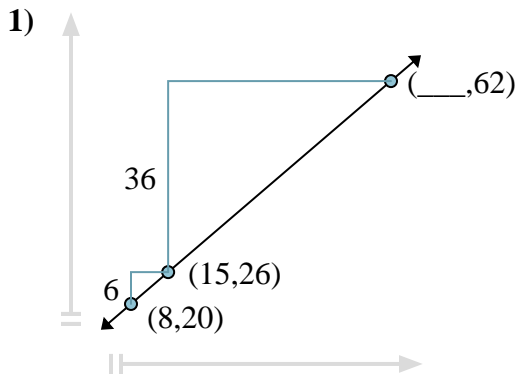

1. _____
2. _____
3. _____
4. _____
5. _____
6. _____
7. _____
8. _____



Trouvez la coordonnée manquante dans chaque problème.

Réponses

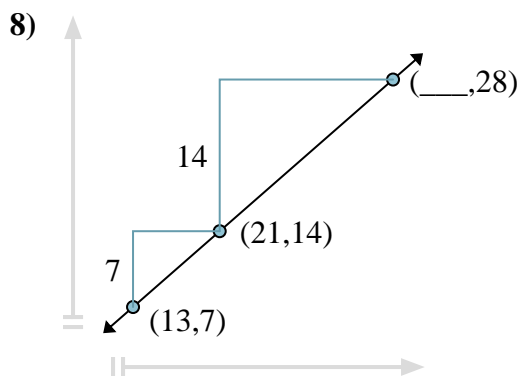
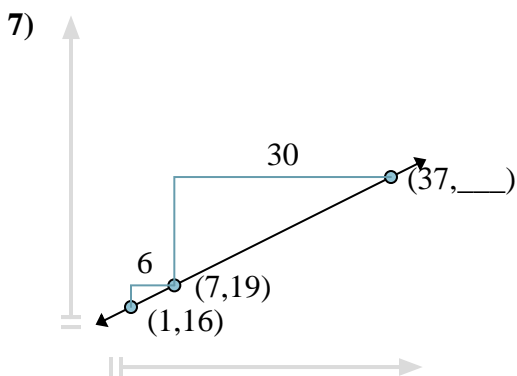
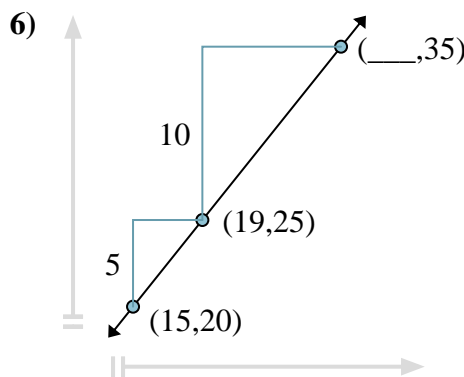
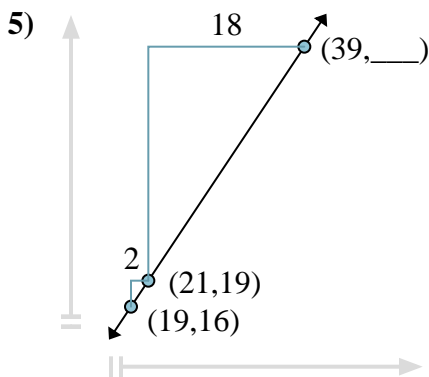
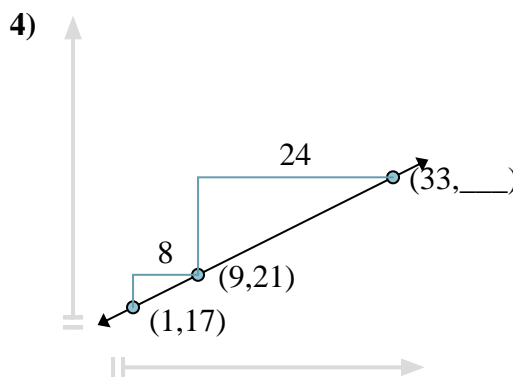
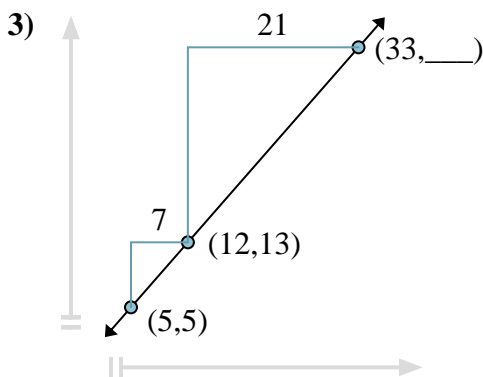
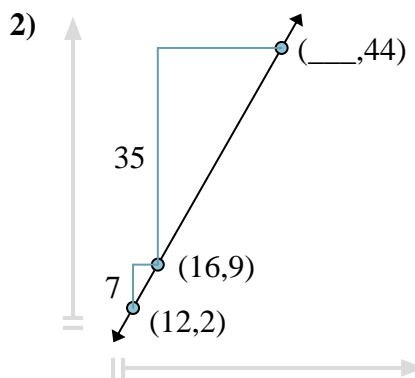
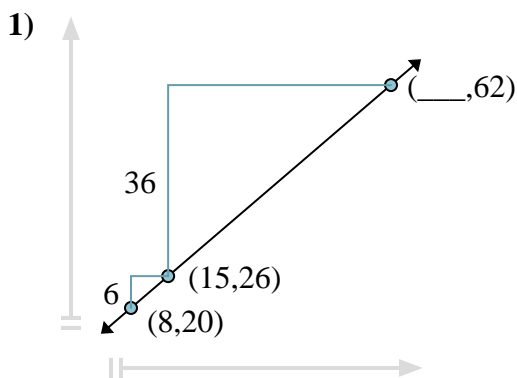

1. 57
2. 36
3. 37
4. 33
5. 46
6. 27
7. 34
8. 37