

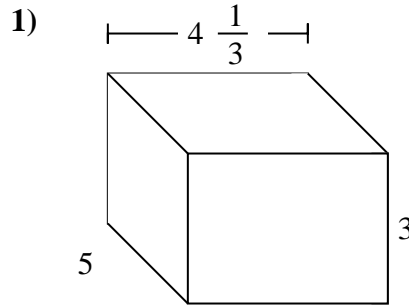

Remplissez chaque prisme rectangulaire de cubes pour déterminer le volume. Chaque prisme est mesuré en cm (pas à l'échelle).

**Réponses**

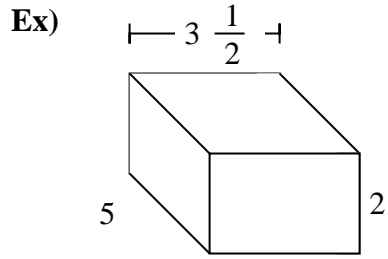

Ex. **35 cm**

1. \_\_\_\_\_

2. \_\_\_\_\_

3. \_\_\_\_\_

4. \_\_\_\_\_

5. \_\_\_\_\_

6. \_\_\_\_\_

7. \_\_\_\_\_

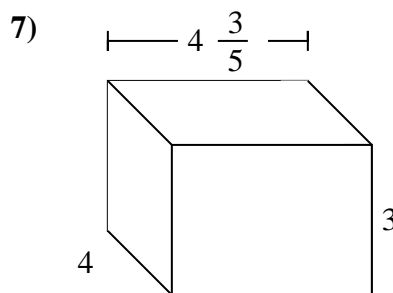
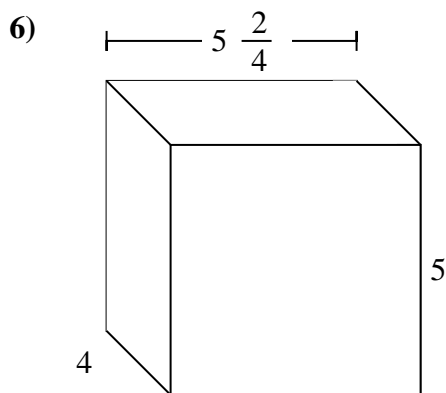
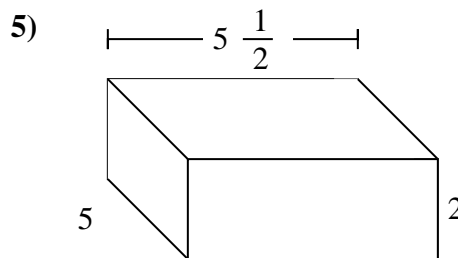
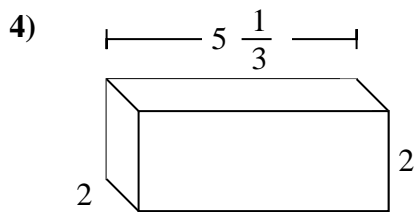
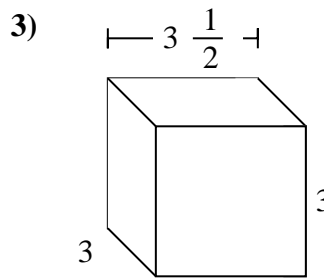
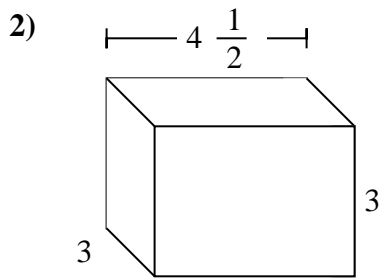



Remplissez chaque prisme rectangulaire de cubes pour déterminer le volume. Chaque prisme est mesuré en cm (pas à l'échelle).

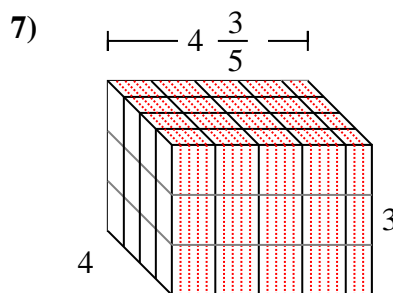
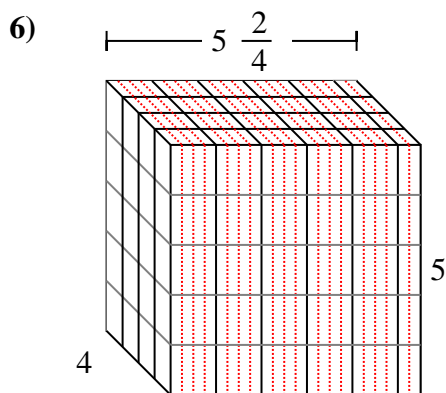
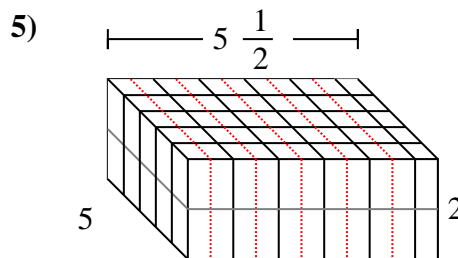
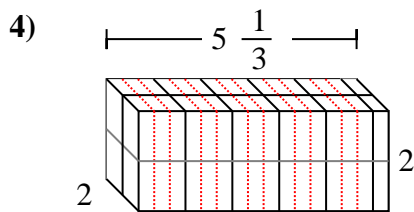
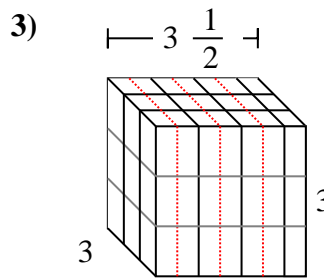
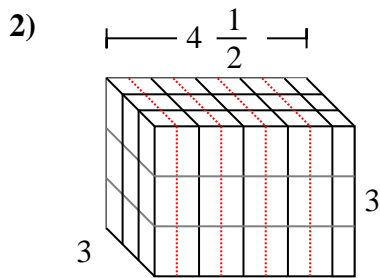
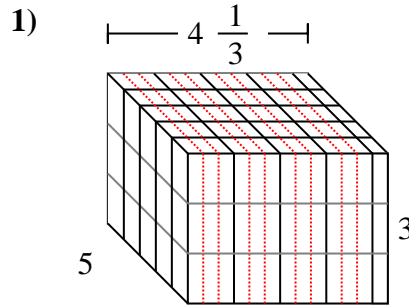
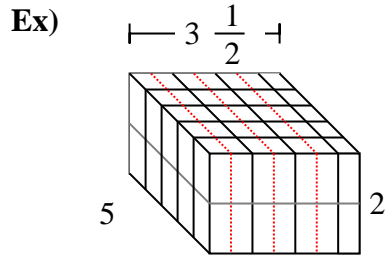

**Réponses**

Ex. 35 cm

1. 65 cm

2. 40 1/2 cm

3. 31 1/2 cm

4. 21 1/3 cm

5. 55 cm

6. 110 cm

7. 55 1/5 cm